



THIS DOCUMENT HAS BEEN DIGITALLY SIGNED AND SEALED BY:

**Aaron Hays**  
2024.01.08 19:35:04-05'00'  
PRINTED COPIES OF THIS DOCUMENT ARE NOT CONSIDERED SIGNED AND SEALED. THE SIGNATURE MUST BE VERIFIED ON THE ELECTRONIC DOCUMENTS.

ARCADIS  
11400 PARKSIDE DRIVE, SUITE 410  
KNOXVILLE, TENNESSEE 37934  
AARON HAYS, P.E. NO.: 126652

THE ABOVE NAMED PROFESSIONAL ENGINEER SHALL BE RESPONSIBLE FOR THE FOLLOWING SHEETS IN ACCORDANCE OF TENN. CODE ANN. §62-2-306.

| SHEET NAME   | SHEET NO.     |
|--|---------------|
| SIGNATURE SHEET .....                                  | ROADWAY-SIGN1 |
| TITLE SHEET .....                                      | 1             |
| ROADWAY INDEX AND STANDARD ROADWAY DRAWINGS .....      | 1A            |
| STANDARD TRAFFIC OPERATIONS DRAWINGS .....             | 1A1           |
| ESTIMATED ROADWAY QUANTITIES .....                     | 2             |
| TYPICAL SECTIONS AND PAVEMENT SCHEDULE .....           | 2B            |
| GENERAL NOTES .....                                    | 2C            |
| SPECIAL NOTES .....                                    | 2D            |
| ENVIRONMENTAL NOTES .....                              | 2E            |
| EROSION PREVENTION AND SEDIMENT CONTROL NOTES .....    | 2E1           |
| TABULATED QUANTITIES .....                             | 2F            |
| UTILITY NOTES AND UTILITY OWNERS .....                 | 3             |
| PAVEMENT EDGE DROP-OFF NOTES FOR TRAFFIC CONTROL ..... | 4             |

| YEAR | PROJECT NO.      | SHEET NO.     |
|------|------------------|---------------|
| 2024 | STP/HSIP-345(12) | ROADWAY-SIGN1 |
|      |                  |               |
|      |                  |               |

**STATE OF TENNESSEE  
DEPARTMENT OF TRANSPORTATION**

**SIGNATURE  
SHEET**

\$SYTIME\$\$\$\$\$  
\$\$\$\$DGN\$PE\$\$\$\$\$



Index Of Sheets  
SEE SHEET NO. 1A

STATE OF TENNESSEE  
DEPARTMENT OF TRANSPORTATION  
BUREAU OF ENGINEERING

**CLAIBORNE COUNTY**

SR-345: FROM NEAR SR-32  
TO NEAR SR-63

RESURFACE & SAFETY  
THIN LIFT, GUARDRAIL, & PAVEMENT MARKINGS

STATE HIGHWAY NO. 345 F.A.H.S. NO. N/A

|  |     |      |
|--|-----|------|
| DOES THIS PROJECT QUALIFY FOR UTILITY CHAPTER 86 | YES | NO X |
| WORK ZONE SIGNIFICANCE DETERMINATION             |     |      |
| SIGNIFICANT                                      | YES | NO X |

|                    |                              |           |
|--------------------|------------------------------|-----------|
| TENN.              | YEAR                         | SHEET NO. |
|                    | 2024                         | 1         |
| FED. AID PROJ. NO. | STP/HSIP-345(12)             |           |
| STATE PROJ. NO.    | 13S345-F3-002; 13S345-F8-002 |           |

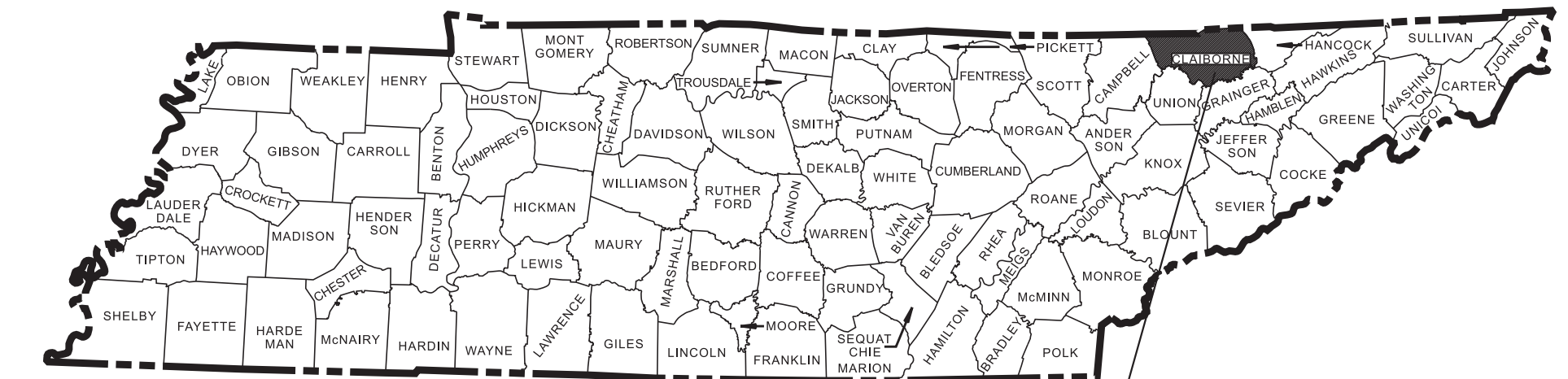

CLAIBORNE CO. SR-345  
BRIDGE ID. # 13005061001, 13023530003

NO EXCLUSIONS

13S345-F3-002  
13S345-F8-002  
END PROJECT NO. STP/HSIP-345(12) RESURFACE & SAFETY  
L.M. 8.51

13S345-F3-002  
13S345-F8-002  
BEGIN PROJECT NO. STP/HSIP-345(12) RESURFACE & SAFETY  
L.M. 0.00

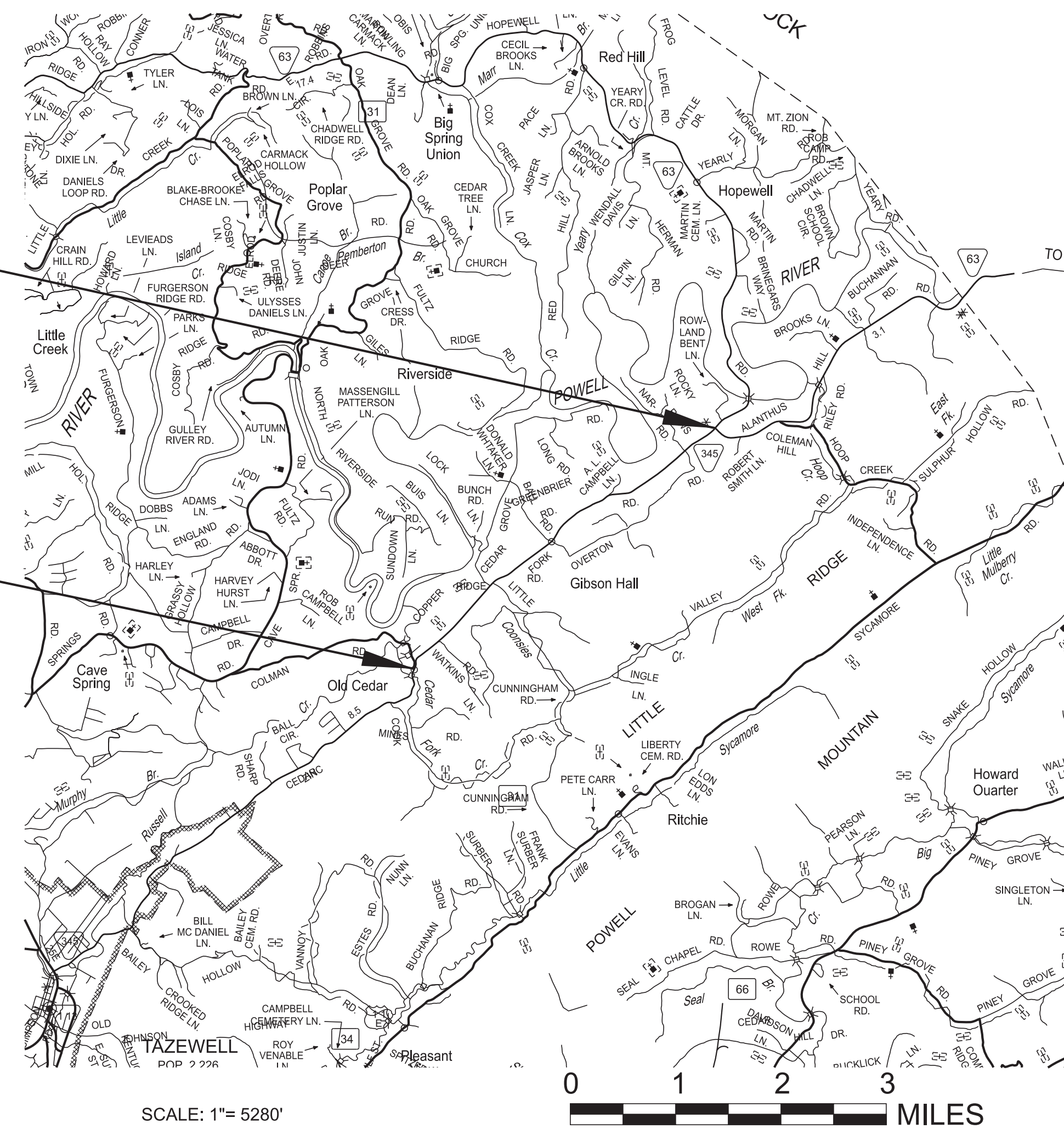

**SPECIAL NOTES**

PROPOSALS MAY BE REJECTED BY THE COMMISSIONER IF ANY OF THE UNIT PRICES CONTAINED THEREIN ARE OBVIOUSLY UNBALANCED, EITHER EXCESSIVE OR BELOW THE REASONABLE COST ANALYSIS VALUE.

THIS PROJECT TO BE CONSTRUCTED UNDER THE STANDARD SPECIFICATIONS OF THE TENNESSEE DEPARTMENT OF TRANSPORTATION DATED JANUARY 1, 2021 AND ADDITIONAL SPECIFICATIONS AND SPECIAL PROVISIONS CONTAINED IN THE PLANS AND IN THE PROPOSAL CONTRACT.

PROJECT LENGTH 8.51 MILES  
TOTAL LANE MILES RESURFACED 17.12 MILES

TDOT PROJECT MANAGER 1: ERIC WILSON, P.E.  
DESIGNED BY: ARCADIS  
DESIGNER : ADAM GRAVITT CHECKED BY : AARON HAYS, P.E.  
P.E. NO. 98013-4203-04  
PIN NO. 131618.00

| TRAFFIC DATA      |        |
|-------------------|--------|
| ADT (2024)        | 3860   |
| POSTED SPEED      |        |
| LM 0.00 - LM 2.43 | 35 MPH |
| LM 2.43 - LM 5.56 | 40 MPH |
| LM 5.56 - LM 8.51 | 45 MPH |

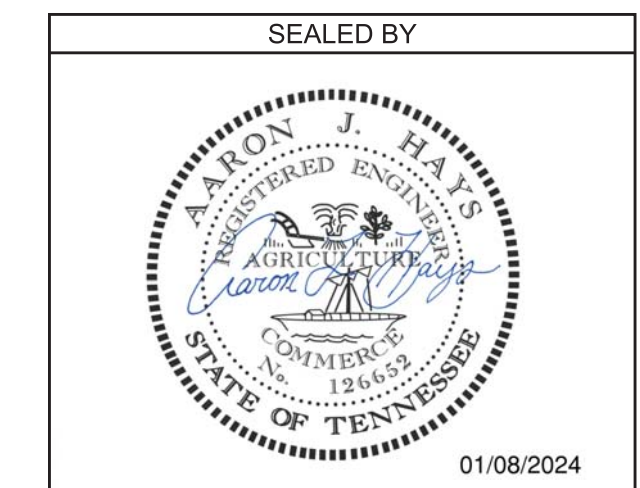

APPROVED: *Will Reid*  
WILL REID, CHIEF ENGINEER  
DATE: \_\_\_\_\_  
APPROVED: *Howard H. Eley*  
HOWARD H. ELEY, COMMISSIONER

U.S. DEPARTMENT OF TRANSPORTATION  
FEDERAL HIGHWAY ADMINISTRATION  
APPROVED: \_\_\_\_\_  
DIVISION ADMINISTRATOR DATE







# STANDARD TRAFFIC OPERATIONS DRAWINGS

| DWG.           | REV.     | DESCRIPTION                                   |
|----------------|----------|---|
| <b>SIGNALS</b> |          |   |
| T-SG-2         | 06-27-16 | LOOP LEAD-INS, CONDUIT AND PULL BOXES         |
| T-SG-3         | 07-11-17 | STANDARD NOTES AND DETAILS OF INDUCTIVE LOOPS |

| TYPE    | YEAR | PROJECT NO.      | SHEET NO. |
|---------|------|------------------|-----------|
| RESURF. | 2024 | STP/HSIP-345(12) | 1A1       |
|         |      |                  |           |
|         |      |                  |           |

1/8/2024 11:30:25 AM L:\SURVDESIGN\PROJECTS\_ORDIRESURFACING\IGNPIN-SHT-STANDARD TRAFFIC OPERATIONS DRAWINGS.DGN

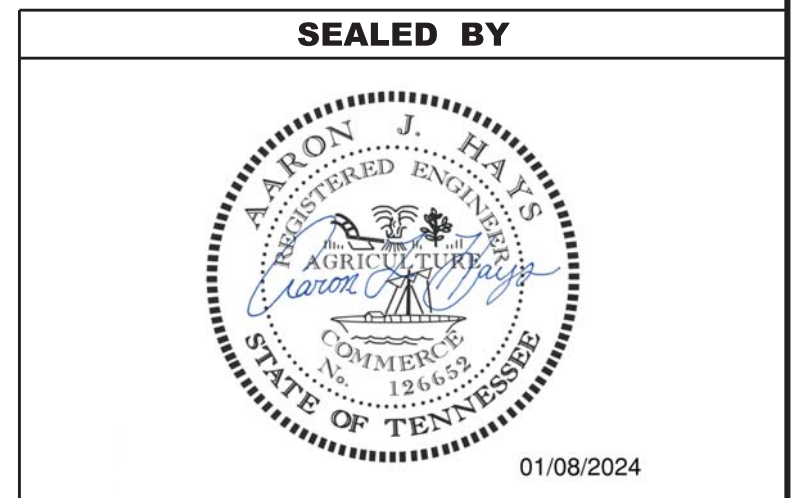

**STATE OF TENNESSEE  
DEPARTMENT OF TRANSPORTATION**

STANDARD  
TRAFFIC  
OPERATIONS  
DRAWINGS



| TYPE    | YEAR | PROJECT NO.      | SHEET NO. |
|---------|------|------------------|-----------|
| RESURF. | 2024 | STP/HSIP-345(12) | 2         |
|         |      |                  |           |

### ESTIMATED ROADWAY QUANTITIES

| ITEM NO. | DESCRIPTION | UNIT   | STP/HSIP-345(12)          | STP/HSIP-345(12)          | TOTAL QUANTITY |
|----------|-------------|--|---------------------------|---------------------------|----------------|
|          |             |  | QUANTITY<br>13S345-F8-002 | QUANTITY<br>13S345-F3-002 |                |
|          | 208-01.05   | BROOMING & DEGRASSING SHOULDERS                          | L.M.                      | 17                        | 17             |
| (1)      | 307-01.15   | ASC MX (PG64-22) (BPMLC-HM) GRADING CS                   | TON                       | 1139                      | 1139           |
| (2)      | 403-01      | BITUMINOUS MATERIAL FOR TACK COAT (TC)                   | TON                       | 91                        | 91             |
| (3)      | 411-03.12   | ACS MX(PG64-22) THIN LIFT D ASPHALT                      | TON                       | 5697                      | 5697           |
| (4)      | 415-01.02   | COLD PLANING BITUMINOUS PAVEMENT                         | S.Y.                      | 58                        | 58             |
| (5)(6)   | 705-02.10   | GUARDRAIL TRANSITION 27IN TO 31IN                        | EACH                      |                           | 2              |
| (7)(6)   | 705-04.10   | EARTH PAD FOR GUARD RAIL END TREATMENT                   | EACH                      |                           | 2              |
| (6)      | 705-06.30   | GR TERMINAL (ENERGY ABSORBING) MASH TL2                  | EACH                      |                           | 2              |
|          | 712-01      | TRAFFIC CONTROL  | LS                        | 1                         | 1              |
|          | 712-04.01   | FLEXIBLE DRUMS (CHANNELIZING)                            | EACH                      | 42                        | 42             |
|          | 712-05.01   | WARNING LIGHTS (TYPE A)                                  | EACH                      | 21                        | 21             |
| (8)      | 712-06      | SIGNS (CONSTRUCTION)                                     | S.F.                      | 733                       | 733            |
|          | 712-08.03   | ARROW BOARD (TYPE C)                                     | EACH                      | 2                         | 2              |
|          | 716-01.21   | SNOWPLOWABLE RAISED PAVEMENT MARKERS (BI-DIR) (1 COLOR)  | EACH                      | 566                       | 566            |
| (9)      | 716-01.22   | SNOWPLOWABLE RAISED PAVEMENT MARKERS (MONO-DIR)(1 COLOR) | EACH                      |                           | 22             |
| (10)     | 716-01.30   | REMOVAL OF SNOWPLOWABLE REFLECTIVE MARKER                | EACH                      | 566                       | 566            |
| (11)     | 716-02.05   | PLASTIC PAVEMENT MARKING (STOP LINE)                     | L.F.                      |                           | 48             |
| (11)     | 716-02.06   | PLASTIC PAVEMENT MARKING (TURN LANE ARROW)               | EACH                      |                           | 4              |
| (11)     | 716-02.11   | PLASTIC PAVEMENT MARKING (6" DOTTED LINE)                | L.F.                      |                           | 200            |
| (11)     | 716-04.01   | PLASTIC PAVEMENT MARKING (STRAIGHT-TURN ARROW)           | EACH                      |                           | 2              |
| (11)(13) | 716-04.04   | PLASTIC PAVEMENT MARKING (TRANSVERSE SHOULDER)           | L.F.                      |                           | 1940           |
| (12)     | 716-05.20   | PAINTED PAVEMENT MARKING (6" LINE)                       | L.M.                      | 14                        | 14             |
|          | 716-13.02   | SPRAY THERMO PVMT MRKNG (60 mil) (6IN LINE)              | L.M.                      | 34                        | 34             |
|          | 717-01      | MOBILIZATION   | LS                        | 1                         | 1              |
|          | 730-14.02   | SAW SLOT   | L.F.                      | 1500                      | 1500           |
|          | 730-14.03   | LOOP WIRE  | L.F.                      | 3000                      | 3000           |

### FOOTNOTES

- (1) TO BE USED FOR SPOT LEVELING. SPOT LEVELING TO BE USED ONLY TO CORRECT DEFICIENCIES ON EXISTING PAVEMENT AND IS NOT TO BE COMBINED WITH OTHER COURSES.
- (2) INCLUDES 3 TONS FOR COUNTY ROADS AND 0.4 TONS FOR EXTRA WORK AT SR-32 AND WATKINS LANE INTERSECTIONS.
- (3) INCLUDES 162 TONS FOR COUNTY ROADS AND 24 TONS FOR EXTRA WORK AT SR-32 AND WATKINS LANE INTERSECTIONS.
- (4) TO BE USED AT THE BEGINNING AND END OF THE PROJECT LIMITS.
- (5) COST INCLUDES THE LENGTH OF GUARDRAIL NECESSARY TO TRANSITION FROM EXISTING HEIGHT OF GUARDRAIL TO 31 INCHES.
- (6) SEE SHEET 2F FOR PROPOSED GUARDRAIL (RESURFACING) TABULATION. INCLUDES THE COST OF REMOVAL OF THE EXISTING END TERMINALS.
- (7) INCLUDES ALL MATERIAL NECESSARY FOR THE CONSTRUCTION OF THE PAD AND ANY NECESSARY EPSC MEASURES.
- (8) SEE SHEET 2F FOR SIGN TABULATED QUANTITIES. THE CONSTRUCTION SIGNING IS TO BE A MINIMUM. OTHER SIGNS MAY BE REQUIRED AS DIRECTED BY THE TDOT OPERATIONS DISTRICT ENGINEER.
- (9) TO BE INSTALLED ALONG TURN LANE SSWL AT SR-32 INTERSECTION (L.M 0.00 TO L.M. 0.06).
- (10) ANY DAMAGE OCCURRED DURING REMOVAL SHALL BE REPAIRED AT THE CONTRACTOR'S EXPENSE AND TO THE SATISFACTION OF THE TDOT OPERATIONS DISTRICT ENGINEER.
- (11) THE CONTRACTOR MAY ELECT TO SUBSTITUTE PREFORMED PLASTIC FOR THERMOPLASTIC. PREFORMED PLASTIC SHALL BE PAID FOR AT THE SAME UNIT PRICE AS BID FOR THERMOPLASTIC.
- (12) TO BE USED FOR TEMPORARY STRIPING DURING PLACEMENT OF SPOT LEVELING ONLY. NO PAYMENT WILL BE MADE FOR TEMPORARY STRIPING DURING PLACEMENT OF THE FINAL SURFACE (ON EITHER EXISTING SURFACE OR FINAL) COURSE DUE TO THE CONTRACTOR'S METHODS OF CONSTRUCTION.
- (13) SEE SHEET 2F FOR THE OPEN FRONTAGE TABULATED QUANTITIES. TO BE USED IN LOCATIONS SHOWN OR AS DIRECTED BY THE REGION'S TRAFFIC OFFICE. ADDITIONAL INFORMATION WILL BE PROVIDED DURING THE PRE-CONSTRUCTION MEETING.

SEALED BY



01/08/2024

STATE OF TENNESSEE  
DEPARTMENT OF TRANSPORTATION

ESTIMATED  
ROADWAY  
QUANTITIES



|         |      |                  |           |
|---------|------|------------------|-----------|
| TYPE    | YEAR | PROJECT NO.      | SHEET NO. |
| RESURF. | 2024 | STP/HSIP-345(12) | 2B        |
|         |      |                  |           |

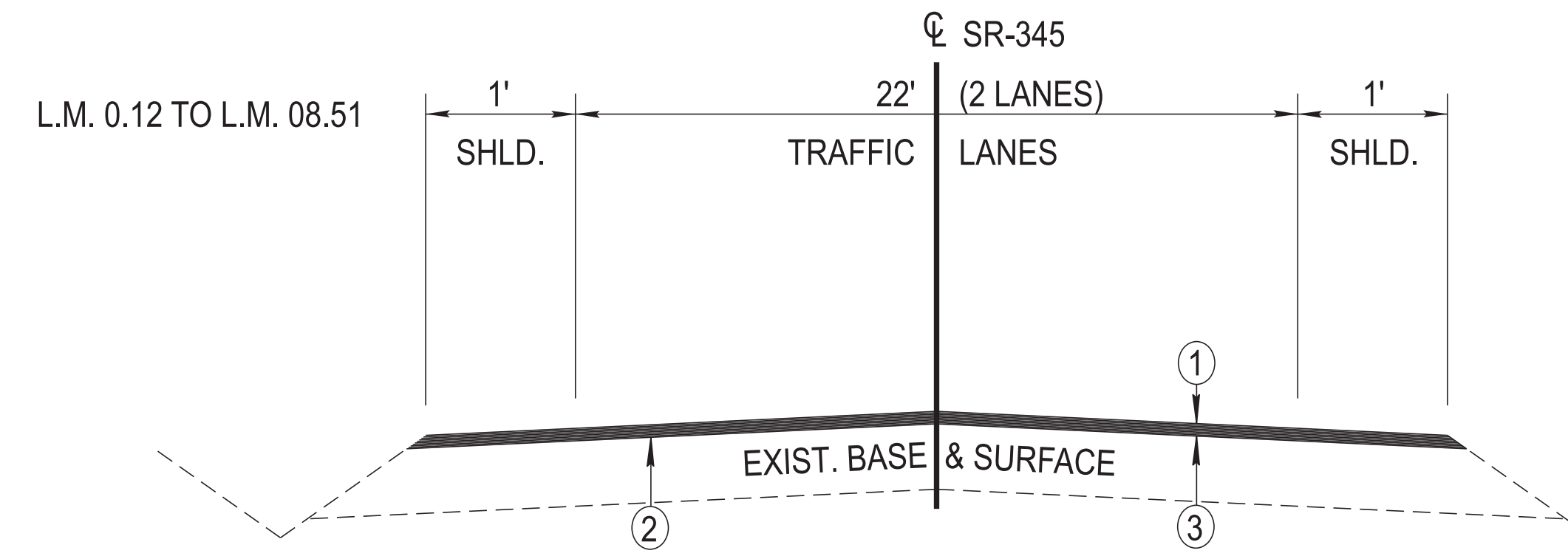
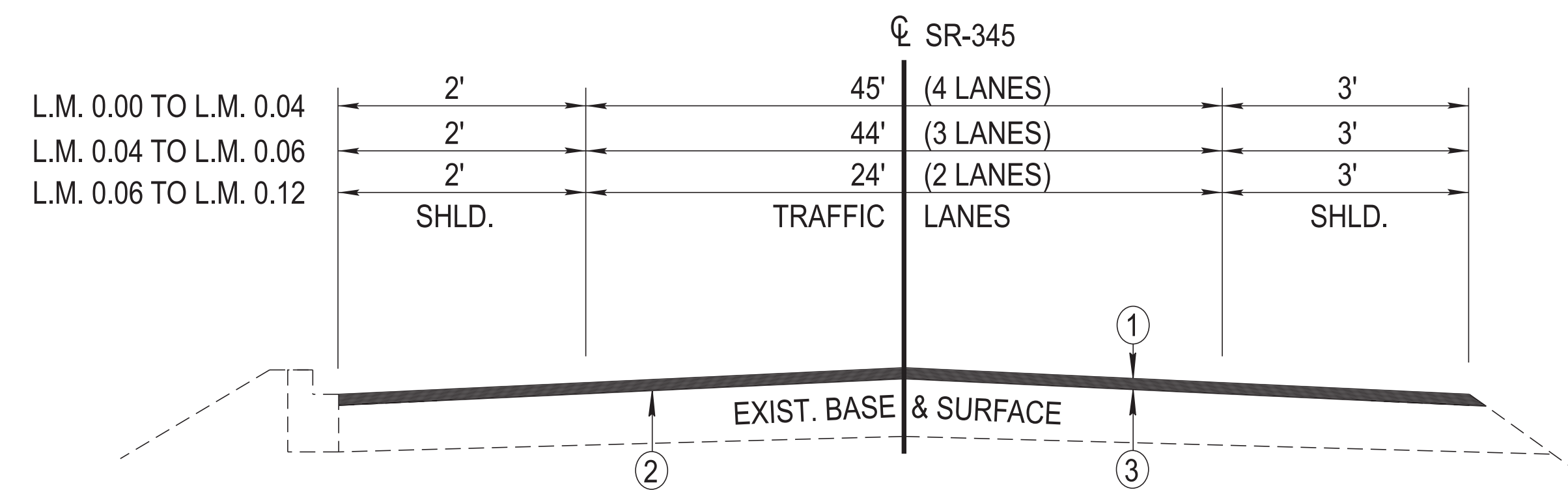

### PROPOSED PAVEMENT SCHEDULE

|   |  |
|---|--|
| ① | THIN LIFT ASPHALT (HM) ¾" (APPROX. 85 LBS/SY)<br>ITEM NO. 411-03.12 ACS MIX (PG64-22) THIN LIFT D ASPHALT    |
| ② | BITUMINOUS PLANT MIX BASE (HM) (SPOT LEVELING)<br>ITEM NO. 307-01.15 ACS MIX (PG64-22) (BPMLC-HM) GRADING CS |
| ③ | TACK COAT (TC) (APPROX. 0.15 GAL/SY)<br>ITEM NO. 403-01 BITUMINOUS MATERIAL FOR TACK COAT (TC)               |
|   | COLD PLANING ¾" TH. (APPROX. 78.8 LBS/SY)<br>ITEM NO. 415-01.02 COLD PLANING BITUMINOUS PAVEMENT             |

#### BRIDGE NOTES:

BRIDGE OVER RUSSELL CREEK (L.M. 0.51) IS TO BE PAVED WITH ¾" 411-03.12 ACS MIX (PG64-22) THIN LIFT D ASPHALT.

BRIDGE OVER CEDAR FORK CREEK (L.M. 4.72) IS TO BE PAVED WITH ¾" 411-03.12 ACS MIX (PG64-22) THIN LIFT D ASPHALT.

SEALED BY



01/08/2024

STATE OF TENNESSEE  
DEPARTMENT OF TRANSPORTATION

TYPICAL  
SECTIONS AND  
PAVEMENT  
SCHEDULE



# GENERAL NOTES

## GRADING

- (1) ANY AREA THAT IS DISTURBED OUTSIDE LIMITS OF CONSTRUCTION DURING THE LIFE OF THIS PROJECT SHALL BE REPAIRED BY THE CONTRACTOR AT HIS EXPENSE.
- (3) THE CONTRACTOR SHALL NOT DISPOSE OF ANY MATERIAL EITHER ON OR OFF STATE-OWNED R.O.W. IN A REGULATORY FLOOD WAY AS DEFINED BY THE FEDERAL EMERGENCY MANAGEMENT AGENCY (FEMA) WITHOUT APPROVAL BY FEMA. ALL MATERIAL SHALL BE DISPOSED OF IN UPLAND (NON-WETLAND) AREAS AND ABOVE ORDINARY HIGH WATER OF ANY ADJACENT WATERCOURSE. THIS DOES NOT ELIMINATE THE NEED TO OBTAIN ANY OTHER LICENSES OR PERMITS THAT MAY BE REQUIRED BY ANY OTHER FEDERAL, STATE OR LOCAL AGENCY.

## GUARDRAIL

- (1) THE CONTRACTOR SHALL NOT REMOVE ANY SECTIONS OF EXISTING GUARDRAIL TO REWORK SHOULDERS OR FLATTEN SLOPES UNTIL THE ENGINEER CONCURS IN THE NECESSITY OF REMOVAL DUE TO CONSTRUCTION REQUIREMENTS AND THE APPROPRIATE WARNING DEVICES ARE INSTALLED. THE PROPOSED GUARDRAIL, INCLUDING ANY ANCHOR SYSTEM, SHALL BE INSTALLED QUICKLY TO MINIMIZE TRAFFIC EXPOSURE TO ANY HAZARD. NO PAYMENT WILL BE MADE FOR A SECTION OF PROPOSED GUARDRAIL, INCLUDING ANCHORS, UNTIL IT IS COMPLETE IN PLACE.
- (3) IF ANY APPROACH END OF A SECTION OF GUARDRAIL OR BRIDGE RAIL MUST TEMPORARILY BE LEFT INCOMPLETE AND EXPOSED TO TRAFFIC, THE CONTRACTOR SHALL USE TWO (2) TEMPORARY BARRICADES OR DRUMS WITH TYPE "A" LIGHTS AND ROUNDED END ELEMENTS AS MINIMUM MEASURES TO PROTECT TRAFFIC FROM THE HAZARD OF AN EXPOSED END. ALL COST OF FURNISHING AND INSTALLING TEMPORARY BARRICADES OR DRUMS WITH TYPE "A" LIGHTS TO DELINEATE GUARDRAIL END AND A TEMPORARY ROUNDED END ELEMENT SHALL BE INCLUDED IN THE COST OF THE PROPOSED GUARDRAIL END TERMINAL.

## MISCELLANEOUS

- (2) THE CONTRACTOR SHALL BE REQUIRED TO REMOVE AND RESET MAILBOXES AND POSTS WHERE AND AS DIRECTED BY THE ENGINEER. COST TO BE INCLUDED IN PRICE BID FOR OTHER CONSTRUCTION ITEMS.
- (3) NOTHING IN THE GENERAL NOTES OR SPECIAL PROVISIONS SHALL RELIEVE THE CONTRACTOR FROM HIS RESPONSIBILITIES TOWARD THE SAFETY AND CONVENIENCE OF THE GENERAL PUBLIC AND THE RESIDENTS ALONG THE PROPOSED CONSTRUCTION AREA.

## PAVEMENT MARKINGS

### TEMPORARY PAVEMENT MARKINGS ON INTERMEDIATE LAYERS

- (2) TEMPORARY PAVEMENT LINE MARKINGS ON INTERMEDIATE LAYERS OF PAVEMENT SHALL BE REFLECTIVE TAPE OR REFLECTORIZED PAINT INSTALLED TO PERMANENT STANDARDS AT THE END OF EACH DAY'S WORK. SHORT, UNMARKED SECTIONS SHALL NOT BE ALLOWED. THESE MARKINGS WILL BE MEASURED AND PAID FOR UNDER ITEM NO. 716-05.20, PAINTED PAVEMENT MARKING (6" LINE), L.M.

### FINAL PAVEMENT MARKING

- (5) THE CONTRACTOR WILL BE REQUIRED TO PERFORM THE FOLLOWING WORK:
  - a. SHOULDERS SHALL BE BROOMED AND DE-GRASSED AND MATERIAL SHALL BE PICKED UP AND REMOVED. THIS WILL BE PAID FOR UNDER ITEM NO. 208-01.05.
  - b. REMOVE ALL GARBAGE AND CONSTRUCTION DEBRIS FROM PROJECT. THE COST FOR THIS WILL BE INCLUDED IN THE PRICE BID FOR OTHER ITEMS OF CONSTRUCTION.
- (11) PERMANENT PAVEMENT LINE MARKINGS SHALL BE 6" SPRAY THERMOPLASTIC (60 mil) INSTALLED TO PERMANENT STANDARDS AT THE END OF EACH DAY'S WORK. SHORT UNMARKED SECTIONS SHALL NOT BE ALLOWED. PAVEMENT MARKINGS WILL BE MEASURED AND PAID FOR UNDER ITEM NO. 716-13.02, SPRAY THERMO PVMT MRKNG (60 mil) (6IN LINE), L.M. THE CONTRACTOR SHALL HAVE THE OPTION OF USING REFLECTORIZED PAINT INSTALLED TO PERMANENT STANDARDS AT THE END OF EACH DAY'S WORK AND THEN INSTALLING THE PERMANENT MARKINGS AFTER THE PAVING OPERATION IS COMPLETED. THE TEMPORARY MARKINGS FOR THE FINAL SURFACE WILL NOT BE MEASURED AND PAID FOR DIRECTLY, BUT THE COSTS ARE TO BE INCLUDED IN THE PRICE BID FOR THE PERMANENT MARKINGS.

## SNOWPLOWABLE REFLECTIVE PAVEMENT MARKERS

- (19) REMOVE EXISTING SNOWPLOWABLE MARKERS PRIOR TO PAVING AND/OR COLD PLANING. REMOVE ALL ADHESIVES PRIOR TO PAVING. PATCH ANY HOLES OR DIVOTS RESULTING FROM THE REMOVAL OF A MARKER IN A MANNER WHICH ENSURES A UNIFORM PAVED SURFACE. PATCH WORK SHALL BE INCLUDED WITH COST OF OTHER ITEMS OF CONSTRUCTION.

## PAVEMENT

### PAVING

- (2) THE CONTRACTOR SHALL BE REQUIRED TO COLD PLANE AND PAVE IN THE DIRECTION OF TRAFFIC.

### RESURFACING

- (4) WHERE DIRECTED BY THE TDOT ENGINEER, THE CONTRACTOR SHALL BE REQUIRED TO SHAPE PUBLIC SIDE ROADS, BUSINESS ENTRANCES, AND PRIVATE DRIVES, AS WELL AS CLEANING OF EXISTING DRAINS BEFORE PLACING MATERIALS. ALL COSTS ARE TO BE INCLUDED IN THE PRICE BID FOR OTHER ITEMS OF CONSTRUCTION.
- (5) ALL PUBLIC SIDE ROADS SHALL BE PAVED ONE PAVEMENT WIDTH THROUGH THE INTERSECTION AS A MINIMUM. A SATISFACTORY TRANSITION FROM THE NEW PAVEMENT TO THE EXISTING GRADE OF THE INTERSECTING PUBLIC ROAD OR BUSINESS ENTRANCE SHALL BE PROVIDED. SHOULD THE PAVEMENT OF THE INTERSECTING PUBLIC ROAD BE DISTRESSED, THE RESURFACING WIDTH MAY BE INCREASED TO THE NORMAL RIGHT OF WAY LINE.
- (6) PRIVATE DRIVEWAYS, FIELD ENTRANCES, AND BUSINESS ENTRANCES WILL BE RESURFACED A PAVEMENT WIDTH (LANE WIDTH) AS A MINIMUM. A PAVEMENT TAPER TO TRANSITION THE NEW PAVEMENT SHALL BE REQUIRED, IT SHALL BE BASED ON AN ADDITIONAL ONE FOOT OF WIDTH PER ONE INCH DEPTH OF PAVEMENT. IF THE SHOULDER IS NARROW ENOUGH THAT THE SUM OF THE SHOULDER AND THE TRANSITION ARE LESS THAN A PAVEMENT WIDTH, THE TRANSITION SHALL OCCUR WITHIN THE PAVEMENT WIDTH. IF THE SUM OF THE SHOULDER AND THE TRANSITION IS GREATER THAN A PAVEMENT WIDTH (LANE WIDTH), THE TRANSITION SHALL OCCUR OUTSIDE OF THE PAVEMENT WIDTH.
- (9) IN ALL CASES, THE LENGTH OF THE PAVEMENT TRANSITION, THE THICKNESS AND WIDTH OF THE RESURFACING AND ANY ADDITIONAL PAVEMENT MATERIALS SHALL BE AS DIRECTED BY THE TDOT ENGINEER.

## SIGNING

- (12) ALL SIGNS WHICH INTERFERE WITH CONSTRUCTION WILL BE RELOCATED OUTSIDE LIMITS OF CONSTRUCTION BY THE CONTRACTOR. UPON COMPLETION OF CONSTRUCTION, THE CONTRACTOR WILL RESTORE THE SIGNS TO ORIGINAL LOCATION. THE CONTRACTOR SHALL CHECK WITH THE REGIONAL TRAFFIC ENGINEER PRIOR TO MOVING ANY PERMANENT SIGNS.

## TRAFFIC CONTROL DIRECTIONAL SIGNING

- (7) WHEN EXISTING "TOURIST ORIENTED DIRECTIONAL SIGNS" (TODS) ARE ON NON-ACCESS CONTROLLED CONSTRUCTION PROJECTS, THE CONTRACTOR SHALL BE RESPONSIBLE FOR KEEPING THESE SIGNS IN FULL VIEW TO THE MOTORING PUBLIC DURING ALL PHASES OF CONSTRUCTION. ALL WORK IN MOVING THESE "TODS" AND TEMPORARY SUPPORTS ARE TO BE PAID FOR UNDER ITEM NO. (712-06) AS DIRECTED BY THE ENGINEER. NEW SUPPORTS AND SIGN FACE FOR FINAL LOCATION WILL BE PAID FOR UNDER OTHER ITEMS OF CONSTRUCTION.

## SIGNALIZATION

- (1) EQUIPMENT AND INSTALLATION OF TRAFFIC SIGNALS SHALL COMPLY WITH TDOT STANDARD SPECIFICATIONS, SECTION 730.
- (6) SALVAGEABLE EQUIPMENT SHALL BECOME THE PROPERTY OF CLAIBORNE COUNTY AND SHALL BE STOCKPILED AT A LOCATION DESIGNATED BY THE ENGINEER FOR PICKUP BY CLAIBORNE COUNTY.
- (7) IF RESURFACING IS INCLUDED IN THE PROJECT, SIGNAL DETECTION LOOPS SHALL BE INSTALLED BEFORE THE FINAL SURFACE IS APPLIED.
- (11) THE PROJECT ENGINEER SHALL NOTIFY THE LOCAL GOVERNMENTAL AGENCY RESPONSIBLE FOR TRAFFIC CONTROL MAINTENANCE AT LEAST ONE DAY IN ADVANCE OF THE COLD PLANING ACTIVITY AT SIGNALIZED INTERSECTIONS WHERE DETECTOR LOOPS ARE ON THE PAVEMENT. THE MAINTAINING AGENCY WILL THEN BE RESPONSIBLE FOR DISCONNECTING THE LOOP DETECTORS AND MAKING ANY NECESSARY TIMING ADJUSTMENTS IN THE SIGNAL CONTROLLER PRIOR TO THE CONSTRUCTION.

- (13) LOOPS SHALL BE INSTALLED IN THE LEVELING COURSE IF A LEVELING COURSE IS PROVIDED.
- (14) LOOP REPLACEMENT SHALL BE IN ACCORDANCE WITH SECTION 730 OF THE STANDARD SPECIFICATIONS.

## CONSTRUCTION WORK ZONE & TRAFFIC CONTROL

- (1) ADVANCED WARNING SIGNS SHALL NOT BE DISPLAYED MORE THAN FORTY-EIGHT (48) HOURS BEFORE PHYSICAL CONSTRUCTION BEGINS. SIGNS MAY BE ERECTED UP TO ONE WEEK BEFORE NEEDED, IF THE SIGN FACE IS FULLY COVERED.
- (2) IF THE CONTRACTOR MOVES OFF THE PROJECT, HE SHALL COVER OR REMOVE ALL UNNEEDED SIGNS AS DIRECTED BY THE ENGINEER. COSTS OF REMOVAL, COVERING, AND REINSTALLING SIGNS SHALL NOT BE MEASURED AND PAID FOR SEPARATELY, BUT ALL COSTS SHALL BE INCLUDED IN THE ORIGINAL UNIT PRICE BID FOR ITEM NO. 712-06, SIGNS (CONSTRUCTION) PER SQUARE FOOT.
- (3) A LONG TERM BUT SPORADIC USE WARNING SIGN, SUCH AS A FLAGGER SIGN, MAY REMAIN IN PLACE WHEN NOT REQUIRED PROVIDED THE SIGN FACE IS FULLY COVERED.
- (4) TRAFFIC CONTROL DEVICES SHALL NOT BE DISPLAYED OR ERECTED UNLESS RELATED CONDITIONS ARE PRESENT NECESSITATING WARNING.
- (5) USE OF BARRICADES, PORTABLE BARRIER RAILS, AND DRUMS SHALL BE LIMITED TO THE IMMEDIATE AREAS OF CONSTRUCTION WHERE A HAZARD IS PRESENT. THESE DEVICES SHALL NOT BE STORED ALONG THE ROADWAY WITHIN THIRTY (30) FEET OF THE EDGE OF THE TRAVELED WAY BEFORE OR AFTER USE UNLESS PROTECTED BY GUARDRAIL, BRIDGE RAIL, AND/OR BARRIERS INSTALLED FOR OTHER PURPOSES FOR ROADWAYS WITH CURRENT ADT'S LESS THAN 1500 AND DESIGN SPEED OF LESS THAN 60 MPH. THIS DISTANCE SHALL INCREASE TO FORTY-FIVE (45) FEET FOR ROADWAYS WITH CURRENT ADT'S OF 1500 OR GREATER AND DESIGN SPEED OF 60 MPH OR GREATER OR ON THE OUTSIDE OF A HORIZONTAL CURVE. THESE DEVICES SHALL BE REMOVED FROM THE CONSTRUCTION WORK ZONE WHEN THE ENGINEER DETERMINES THEY ARE NO LONGER NEEDED. WHERE THERE IS INSUFFICIENT RIGHT-OF-WAY TO PROVIDE FOR THIS REQUIRED SETBACK, THE CONTRACTOR SHALL DETERMINE THE ALTERNATE LOCATIONS AND REQUEST THE ENGINEER'S APPROVAL TO USE THEM.
- (6) THE CONTRACTOR SHALL NOT BE PERMITTED TO PARK ANY VEHICLES OR CONSTRUCTION EQUIPMENT DURING PERIODS OF INACTIVITY, WITHIN THIRTY (30) FEET OF THE EDGE OF PAVEMENT WHEN THE LANE IS OPEN TO TRAFFIC UNLESS PROTECTED BY GUARDRAIL, BRIDGE RAIL, AND/OR BARRIERS INSTALLED FOR OTHER PURPOSES FOR ROADWAYS WITH CURRENT ADT'S LESS THAN 1500 AND DESIGN SPEED OF LESS THAN 60 MPH. THIS DISTANCE SHALL BE INCREASED TO FORTY-FIVE (45) FEET FOR ROADWAYS WITH CURRENT ADT'S OF 1500 OR GREATER AND DESIGN SPEED OF 60 MPH OR GREATER OR ON THE OUTSIDE OF A HORIZONTAL CURVE. PRIVATELY OWNED VEHICLES SHALL NOT BE ALLOWED TO PARK WITHIN THIRTY (30) FEET OF AN OPEN TRAFFIC LANE AT ANY TIME UNLESS PROTECTED AS DESCRIBED ABOVE FOR ROADWAYS WITH CURRENT ADT'S LESS THAN 1500 AND DESIGN SPEED OF LESS THAN 60 MPH. THIS DISTANCE SHALL BE INCREASED TO FORTY-FIVE (45) FEET FOR ROADWAYS WITH CURRENT ADT'S OF 1500 OR GREATER AND DESIGN SPEED OF 60 MPH OR GREATER OR ON THE OUTSIDE OF A HORIZONTAL CURVE. WHERE THERE IS INSUFFICIENT RIGHT-OF-WAY TO PROVIDE FOR THIS REQUIRED SETBACK, THE CONTRACTOR SHALL DETERMINE THE ALTERNATE LOCATIONS AND REQUEST THE ENGINEER'S APPROVAL TO USE THEM.
- (7) ALL DETOUR AND CONSTRUCTION SIGNING SHALL BE IN STRICT ACCORDANCE WITH THE MANUAL ON UNIFORM TRAFFIC CONTROL DEVICES.
- (8) ALL DETOURS SHALL BE PAVED, STRIPED, SIGNED, AND FLEXIBLE DRUMS ARE TO BE IN PLACE BEFORE IT IS OPENED TO TRAFFIC.
- (9) THE CONTRACTOR SHALL BE RESPONSIBLE FOR STAKING CONSTRUCTION SIGNS. THE COST OF THIS WORK SHALL BE INCLUDED IN ITEM NO. 712-06, SIGNS (CONSTRUCTION), S.F.

| TYPE    | YEAR | PROJECT NO.      | SHEET NO. |
|---------|------|------------------|-----------|
| RESURF. | 2024 | STP/HSIP-345(12) | 2C        |
|         |      |                  |           |
|         |      |                  |           |

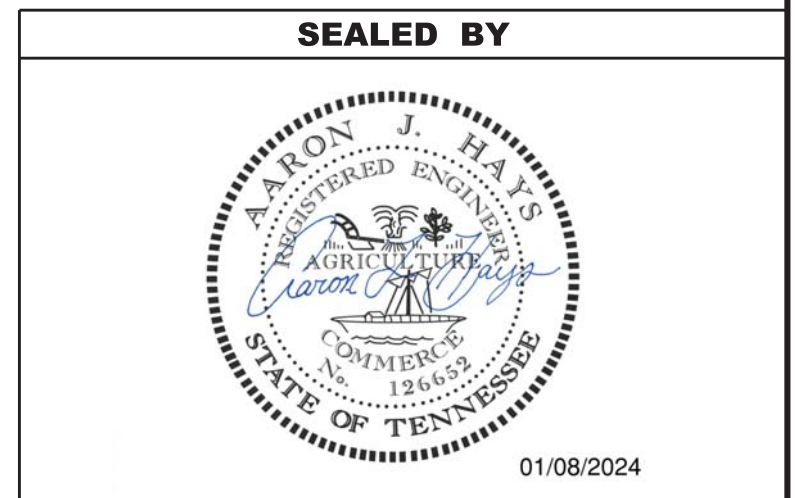

STATE OF TENNESSEE  
DEPARTMENT OF TRANSPORTATION

GENERAL  
NOTES



# SPECIAL NOTES

## MISCELLANEOUS

- (1) ALL GUARDRAIL, GUARDRAIL POSTS AND SIGNS WHICH INTERFERE WITH CONSTRUCTION WILL BE REMOVED AND STORED BY STATE FORCES.
- (2) ALL SIGNING AND PAVEMENT MARKINGS ARE TO BE IN ACCORDANCE WITH THE CURRENT EDITION OF THE MANUAL ON UNIFORM TRAFFIC CONTROL DEVICES.

## PAVEMENT

### RESURFACING

- (1) SURFACE IS TO BE CROWNED AS DIRECTED BY THE TDOT OPERATIONS DISTRICT ENGINEER.
- (2) THE CONTRACTOR WILL PLACE THE SPOT LEVELING WHERE AND AS DIRECTED BY THE TDOT OPERATIONS DISTRICT ENGINEER.
- (3) ALL SURPLUS PATCHING, JOINT MATERIAL AND CRACK SEALANT IS TO BE REMOVED BEFORE PLACING THE FIRST LAYER OF ASPHALT.
- (4) STATE FORCES WILL REMOVE ALL RAISED PAVEMENT MARKERS, IF ANY, BEFORE RESURFACING IS BEGUN.
- (5) COLD PLANING IS TO BE DONE IMMEDIATELY PRIOR TO THE COMMENCEMENT OF PAVING OPERATIONS. COLD PLANED SURFACES ARE NOT TO BE LEFT EXPOSED FOR MORE THAN FIVE (5) CALENDAR DAYS BEFORE BEING OVERLAYED BY THE FIRST COURSE OF ASPHALT. IF NECESSARY, COLD PLANING OPERATIONS ARE TO BE SUSPENDED TO ALLOW PAVING OPERATIONS TO CATCH UP. AFTER COLD PLANING AND PRIOR TO ALLOWING USE BY TRAFFIC, THE CONTRACTOR WILL RAMP ASPHALT AROUND EXISTING UTILITIES TO ELIMINATE HAZARD TO VEHICLES. ALL COLD PLANING REQUIRED ON CITY STREETS OR SIDE ROADS WILL BE PAID FOR AT THE UNIT PRICE BID FOR ITEM NO. 415-01.02.

## SIGNALIZATION

- (1) LOOP REPLACEMENT SHALL BE IN ACCORDANCE WITH THE TDOT STANDARD SPECIFICATIONS, SECTION 730.
- (2) SIGNAL DETECTION LOOPS SHALL BE INSTALLED BEFORE THE FINAL SURFACE IS APPLIED.

| TYPE    | YEAR | PROJECT NO.      | SHEET NO. |
|---------|------|------------------|-----------|
| RESURF. | 2024 | STP/HSIP-345(12) | 2D        |
|         |      |                  |           |
|         |      |                  |           |

SEALED BY



01/08/2024

STATE OF TENNESSEE  
DEPARTMENT OF TRANSPORTATION

SPECIAL  
NOTES



# ENVIRONMENTAL NOTES

## SUBSECTION 1 – ENVIRONMENTAL GENERAL NOTES

### ENVIRONMENTAL GENERAL NOTES

#### NATURAL RESOURCES

- (4) THE OPERATION OF EQUIPMENT IN WATERS OF THE STATE/U.S., INCLUDING WETLANDS AND EPHEMERAL, INTERMITTENT, AND PERENNIAL STREAMS, IS NOT ALLOWED.
- (9) THE CONTRACTOR SHALL TAKE APPROPRIATE STEPS PRIOR TO ANY CONSTRUCTION AND MAINTENANCE ACTIVITIES TO ENSURE THAT ENVIRONMENTAL FEATURES (E.G., STREAMS, WETLANDS, SPRINGS, ETC.) ARE NOT IMPACTED BEYOND PERMITTED LOCATIONS. IF THE CONTRACTOR OR TDOT INSPECTOR IS UNSURE OF THE IDENTITY OF AN ENVIRONMENTAL FEATURE, THE INSPECTOR SHALL CONTACT THE TDOT REGION ENVIRONMENTAL TECH GROUP IMMEDIATELY.

#### SPECIES

- (11) SHOULD CLIFF SWALLOW OR BARN SWALLOW NESTS, EGGS, OR BIRDS (YOUNG AND ADULTS) BE PRESENT, THE CONTRACTOR SHALL CONTACT THE REGIONAL ECOLOGY OFFICE TO DETERMINE IF SEASONAL RESTRICTIONS WILL BE NECESSARY. GENERALLY, BIRDS, NESTS, AND EGGS MAY NOT BE DISTURBED BETWEEN APRIL 15 AND JULY 31. FROM AUGUST 1 TO APRIL 14, NESTS CAN BE REMOVED OR DESTROYED SO LONG AS BIRDS OR EGGS ARE NOT PRESENT, AND MEASURES IMPLEMENTED TO PREVENT FUTURE NEST BUILDING AT THE SITE (I.E., CLOSING OFF AREA USING NETTING).
- (12) IF THE REMOVAL OF ANY TREES WITH A DIAMETER AT BREAST HEIGHT (DBH) GREATER THAN 3 INCHES IS DEEMED NECESSARY THE TDOT SUPERVISOR SHALL CONTACT THE TDOT ENVIRONMENTAL DIVISION, ECOLOGY SECTION IMMEDIATELY.

#### PERMITS, PLANS & RECORDS

- (15) IF A CHANGE IN PROJECT SCOPE OCCURS DURING CONSTRUCTION, INCLUDING VALUE ENGINEERING, THE TDOT PERMIT SECTION SHALL BE CONTACTED TO DETERMINE WHETHER PERMIT REVISIONS ARE NEEDED. THE ROADWAY DESIGN DIVISION SHALL BE CONTACTED TO DETERMINE IF ANY PLAN REVISIONS ARE NEEDED.

| TYPE    | YEAR | PROJECT NO.      | SHEET NO. |
|---------|------|------------------|-----------|
| RESURF. | 2024 | STP/HSIP-345(12) | 2E        |
|         |      |                  |           |
|         |      |                  |           |

SEALED BY



01/08/2024

STATE OF TENNESSEE  
DEPARTMENT OF TRANSPORTATION

ENVIRONMENTAL  
NOTES



**SUBSECTION 3 – EROSION PREVENTION AND SEDIMENT CONTROL GENERAL NOTES**

**EROSION PREVENTION AND SEDIMENT CONTROL GENERAL NOTES**

**DISTURBED AREA**

- (1) IF DISTURBED ACREAGE IS EQUAL TO ONE ACRE OR MORE, PLEASE CONTACT TDOT ENVIRONMENTAL DIVISION, PERMITS SECTION AS SOON AS POSSIBLE BECAUSE AN NPDES PERMIT WILL BE REQUIRED.

**SEDIMENT CONTROL**

- (6) EPSC MEASURES SHALL BE INSTALLED AND FUNCTIONAL PRIOR TO ANY EARTH MOVING OPERATIONS AND SHALL BE MAINTAINED THROUGHOUT THE CONSTRUCTION PERIOD EXCEPT AS SUCH WORK MAY BE NECESSARY TO INSTALL EPSC MEASURES.
- (8) THE CONTRACTOR SHALL ESTABLISH AND MAINTAIN A PROACTIVE METHOD TO PREVENT THE OFFSITE MIGRATION OR DEPOSIT OF SEDIMENT OFF THE PROJECT LIMITS (E.G. R.O.W., EASEMENTS, ETC.), INTO WATERS OF THE STATE/U.S., OR ONTO ROADWAYS USED BY THE GENERAL PUBLIC. IF SEDIMENT ESCAPES THE CONSTRUCTION SITE, OFFSITE ACCUMULATIONS OF SEDIMENT THAT HAVE NOT REACHED A STREAM MUST BE REMOVED AT A FREQUENCY SUFFICIENT TO MINIMIZE OFFSITE IMPACTS (E.G., FUGITIVE SEDIMENT THAT HAS ESCAPED THE CONSTRUCTION SITE AND HAS COLLECTED IN A STREET MUST BE REMOVED SO THAT IT IS NOT SUBSEQUENTLY WASHED INTO STORM SEWERS AND STREAMS BY THE NEXT RAIN AND/OR SO THAT IT DOES NOT POSE A SAFETY HAZARD TO USERS OF PUBLIC STREETS). ARRANGEMENTS CONCERNING REMOVAL OF SEDIMENT ON ADJOINING PROPERTY MUST BE NEGOTIATED WITH THE ADJOINING PROPERTY OWNER BEFORE REMOVAL OF SEDIMENT.

**GOOD HOUSEKEEPING MEASURES & WASTE DISPOSAL**

- (29) THE CONTRACTOR SHALL ESTABLISH AND MAINTAIN A PROACTIVE METHOD TO PREVENT LITTER AND CONSTRUCTION WASTES FROM ENTERING WATERS OF THE STATE/U.S. THESE MATERIALS SHALL BE REMOVED FROM STORMWATER EXPOSURE PRIOR TO ANTICIPATED STORM EVENTS OR BEFORE BEING CARRIED OFFSITE BY WIND, OR OTHERWISE PREVENTED FROM BECOMING A POLLUTANT SOURCE FOR STORMWATER DISCHARGES. AFTER USE, MATERIALS USED FOR EPSC SHALL BE REMOVED FROM THE SITE.
- (30) THE CONTRACTOR SHALL TAKE APPROPRIATE STEPS TO ENSURE THAT PETROLEUM PRODUCTS OR OTHER CHEMICAL POLLUTANTS ARE PREVENTED FROM ENTERING WATERS OF THE STATE/U.S. ALL EQUIPMENT REFUELING, SERVICING, AND STAGING AREAS SHALL COMPLY WITH ALL LOCAL, STATE, AND FEDERAL LAWS, RULES, REGULATIONS, AND ORDINANCES, INCLUDING THOSE OF THE NATIONAL FIRE PROTECTION ASSOCIATION. APPROPRIATE CONTAINMENT MEASURES FOR THESE AREAS SHALL BE USED.
- (31) CONTRACTORS SHALL PROVIDE DESIGNATED TRUCK WASHOUT AREAS ON THE SITE. THESE AREAS MUST BE SELF CONTAINED, NOT CONNECTED TO ANY STORMWATER OUTLET OF THE SITE, AND PROPERLY SIGNED. WASH DOWN OR WASTE DISCHARGE OF CONCRETE TRUCKS SHALL NOT BE PERMITTED ONSITE UNLESS PROPER SETTLEMENT AREAS HAVE BEEN PROVIDED IN ACCORDANCE WITH BOTH STATE AND FEDERAL REGULATIONS.
- (32) WHEEL WASH WATER SHALL BE COLLECTED AND ALLOWED TO SETTLE OUT SUSPENDED SOLIDS PRIOR TO DISCHARGE. WHEEL WASH WATER SHALL NOT BE DISCHARGED DIRECTLY INTO ANY STORMWATER SYSTEM OR STORMWATER TREATMENT SYSTEM.
- (33) IF PORTABLE SANITARY FACILITIES ARE PROVIDED ON CONSTRUCTION SITES, SANITARY WASTE SHALL BE COLLECTED FROM THE PORTABLE UNITS IN A TIMELY MANNER BY A LICENSED WASTE MANAGEMENT CONTRACTOR OR AS REQUIRED BY ANY REGULATIONS. THE CONTRACTOR SHALL OBTAIN ANY AND ALL NECESSARY PERMITS TO DISPOSE OF SANITARY WASTE.
- (34) ONLY CONSTRUCTION PRODUCTS NEEDED SHALL BE STORED ONSITE BY THE CONTRACTOR. THE CONTRACTOR SHALL STORE ALL MATERIALS UNDER COVER AND IN APPROPRIATE CONTAINERS. PRODUCTS MUST BE STORED IN ORIGINAL CONTAINERS AND LABELED. MATERIAL MIXING SHALL BE CONDUCTED IN ACCORDANCE WITH THE MANUFACTURER'S RECOMMENDATIONS. THE CONTRACTOR'S RESPONSIBLE PARTY SHALL INSPECT MATERIALS STORAGE AREAS REGULARLY TO ENSURE PROPER USE AND DISPOSAL.
- (35) WHEN POSSIBLE, ALL PRODUCTS SHALL BE USED COMPLETELY BEFORE PROPERLY DISPOSING OF THE CONTAINER OFFSITE. THE

MANUFACTURER'S DIRECTIONS FOR DISPOSAL OF MATERIALS AND CONTAINERS SHALL BE FOLLOWED.

- (36) ALL PAINT CONTAINERS SHALL BE TIGHTLY SEALED AND STORED WHEN NOT REQUIRED FOR USE. EXCESS PAINT SHALL BE DISPOSED OF ACCORDING TO THE MANUFACTURER'S INSTRUCTIONS AND APPLICABLE STATE AND LOCAL REGULATIONS.
- (37) ALL HAZARDOUS WASTE MATERIALS SHALL BE DISPOSED OF IN A MANNER WHICH IS COMPLIANT WITH LOCAL OR STATE REGULATIONS. SITE PERSONNEL SHALL BE INSTRUCTED IN THESE PRACTICES, AND THE INDIVIDUAL DESIGNATED AS THE CONTRACTOR'S RESPONSIBLE PARTY SHALL BE RESPONSIBLE FOR SEEING THAT THESE PRACTICES ARE FOLLOWED. THE CONTRACTOR SHALL OBTAIN ANY AND ALL NECESSARY PERMITS TO DISPOSE OF HAZARDOUS MATERIAL.
- (38) OPEN BURNING IS PROHIBITED UNLESS IT IS SPECIFICALLY ALLOWED BY LAW. IF ALLOWED, NATURAL VEGETATION, TREES, AND UNTREATED LUMBER SHALL BE THE ONLY MATERIALS THAT CAN BE OPEN BURNED. THE CONTRACTOR SHALL BE RESPONSIBLE FOR OBTAINING ALL APPLICABLE STATE AND LOCAL PERMITS PRIOR TO ANY BURNING.
- (39) DISPOSAL OF ONSITE VEGETATION AND TREES BY CHIPPING THEM INTO MULCH IS PREFERABLE TO OPEN BURNING. THIS MULCH MAY BE USED AS AN ONSITE SOIL STABILIZATION MEASURE WHERE APPROPRIATE.
- (40) WASTE MATERIAL (EARTH, ROCK, ASPHALT, CONCRETE, ETC.) NOT REQUIRED FOR THE CONSTRUCTION OF THE PROJECT WILL BE DISPOSED OF BY THE CONTRACTOR. IMPACTS TO WATERS OF THE STATE/U.S. SHALL BE AVOIDED IF POSSIBLE. IF UNAVOIDABLE, THE CONTRACTOR WILL OBTAIN ANY AND ALL NECESSARY PERMITS INCLUDING, BUT NOT LIMITED TO NPDES, AQUATIC RESOURCES ALTERATION PERMIT(S), CORPS OF ENGINEERS SECTION 404 PERMITS, AND TVA SECTION 26A PERMITS TO DISPOSE OF WASTE MATERIALS.

**SPILL PREVENTION, MANAGEMENT & NOTIFICATION**

- (44) ALL ONSITE VEHICLES SHALL BE MONITORED FOR LEAKS AND RECEIVE REGULAR PREVENTIVE MAINTENANCE TO REDUCE THE CHANCE OF LEAKAGE AND SPILLS.
- (45) FOR ALL HAZARDOUS MATERIALS STORED ONSITE, THE MANUFACTURER'S RECOMMENDED METHODS FOR SPILL CLEAN UP SHALL BE CLEARLY POSTED. SITE PERSONNEL SHALL BE MADE AWARE OF THE PROCEDURES AND THE LOCATIONS OF THE INFORMATION AND CLEANUP SUPPLIES.
- (46) APPROPRIATE CLEANUP MATERIALS AND EQUIPMENT SHALL BE MAINTAINED BY THE CONTRACTOR IN THE MATERIALS STORAGE AREA ONSITE AND UNDER COVER. SPILL RESPONSE EQUIPMENT SHALL BE INSPECTED AND MAINTAINED BY THE CONTRACTOR AS NECESSARY TO REPLACE ANY MATERIALS USED IN SPILL RESPONSE ACTIVITIES.
- (47) ALL SPILLS SHALL BE CLEANED IMMEDIATELY AFTER DISCOVERY AND THE MATERIALS DISPOSED OF PROPERLY. THE SPILL AREA SHALL BE KEPT WELL VENTILATED AND PERSONNEL WILL WEAR APPROPRIATE PROTECTIVE CLOTHING TO PREVENT INJURY FROM CONTACT WITH A HAZARDOUS SUBSTANCE.
- (48) THE CONTRACTOR'S RESPONSIBLE PARTY SHALL BE THE SPILL PREVENTION AND CLEANUP COORDINATOR. THE CONTRACTOR IS RESPONSIBLE FOR ENSURING THAT THE SITE SUPERINTENDENT HAS HAD APPROPRIATE TRAINING FOR HAZARDOUS MATERIALS HANDLING, SPILL MANAGEMENT, AND CLEANUP.
- (49) IF AN OIL SHEEN IS OBSERVED ON SURFACE WATER (E.G. SETTLING PONDS, DETENTION PONDS, SWALES), ACTION SHALL BE TAKEN IMMEDIATELY TO REMOVE THE MATERIAL CAUSING THE SHEEN. THE CONTRACTOR SHALL USE APPROPRIATE MATERIALS TO CONTAIN AND ABSORB THE SPILL. THE SOURCE OF THE OIL SHEEN WILL ALSO BE IDENTIFIED AND REMOVED OR REPAIRED AS NECESSARY TO PREVENT FURTHER RELEASES.
- (50) FERTILIZERS SHALL BE APPLIED ONLY IN THE AMOUNTS SPECIFIED. ONCE APPLIED, FERTILIZERS SHALL BE WORKED INTO THE SOIL TO LIMIT THE EXPOSURE TO STORMWATER.
- (51) IF A SPILL OCCURS THE CONTRACTOR'S RESPONSIBLE PARTY SHALL BE RESPONSIBLE FOR COMPLETING THE SPILL REPORTING FORM AND FOR REPORTING THE SPILL TO THE TDOT PROJECT RESPONSIBLE PARTY. ALL SPILLS MUST BE REPORTED TO THE APPROPRIATE AGENCY, AND MEASURES SHALL BE TAKEN IMMEDIATELY TO PREVENT THE POLLUTION OF WATERS OF THE STATE/U.S., INCLUDING GROUNDWATER, SHOULD A SPILL OCCUR.
- (52) WHERE A RELEASE CONTAINING A HAZARDOUS SUBSTANCE IN AN AMOUNT EQUAL TO OR IN EXCESS OF A REPORTABLE QUANTITY ESTABLISHED UNDER EITHER 40 CFR 117 OR 40 CFR 302 OCCURS DURING A 24 HOUR PERIOD. SEE THE LATEST TENNESSEE GENERAL PERMIT NO.

TNR100000 STORMWATER DISCHARGES FROM CONSTRUCTION ACTIVITIES SECTION 5.1 FOR REPORTING REQUIREMENTS.

- (53) CONTRACTOR'S BULK FUEL AND PETROLEUM PRODUCTS STORED ONSITE OR ADJACENT TO THE R.O.W. IN ABOVE GROUND STORAGE CONTAINERS WITH A COMBINED CAPACITY OF 1320 GALLONS OR MORE SHALL HAVE SECONDARY CONTAINMENT. THE CONTRACTOR SHALL BE RESPONSIBLE FOR PREPARING A SPILL PREVENTION CONTROL AND COUNTERMEASURE (SPCC) PLAN FOR THE BULK STORAGE AND BE SOLELY RESPONSIBLE FOR OBTAINING ANY NECESSARY LOCAL, STATE, AND FEDERAL PERMITS. THE SPCC PLAN AND/OR PERMITS SHALL BE KEPT ONSITE AND A COPY PROVIDED TO THE TDOT PROJECT RESPONSIBLE PARTY PRIOR TO STORING 1320 GALLONS ON SITE.

| TYPE    | YEAR | PROJECT NO.      | SHEET NO. |
|---------|------|------------------|-----------|
| RESURF. | 2024 | STP/HSIP-345(12) | 2E1       |
|         |      |                  |           |

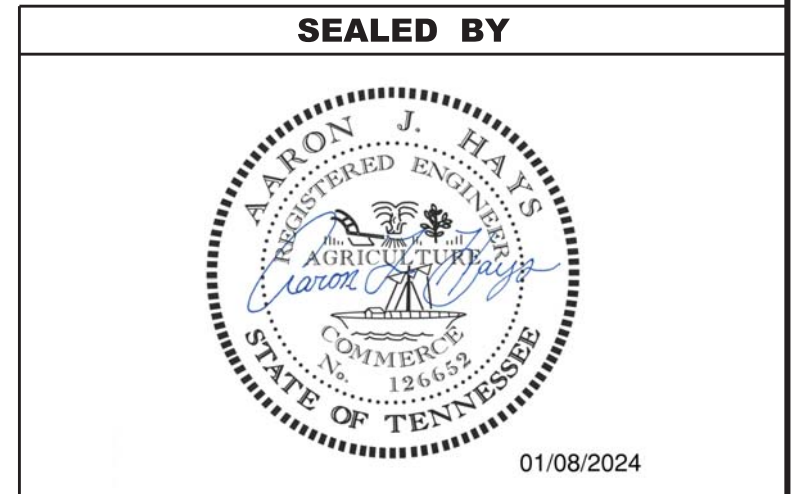

**STATE OF TENNESSEE  
DEPARTMENT OF TRANSPORTATION**

**EROSION  
PREVENTION  
AND SEDIMENT  
CONTROL NOTES**



| TYPE    | YEAR | PROJECT NO.      | SHEET NO. |
|---------|------|------------------|-----------|
| RESURF. | 2024 | STP/HSIP-345(12) | 2F        |
|         |      |                  |           |

| TRAFFIC CONTROL SIGN TABULATION (RESURFACING) |                        |                   |     |      |                             |                            |
|---|------------------------|-------------------|-----|------|-----------------------------|----------------------------|
| M.U.T.C.D.<br>SIGN NO.                        | LEGEND \ DESCRIPTION   | SIZE<br>IN INCHES |     | S.F. | TOTAL<br>NUMBER<br>REQUIRED | ITEM NO.<br>712-06<br>S.F. |
|   |                        | L                 | W   |      |                             |                            |
| G20-1   | ROAD WORK NEXT 9 MILES | 48"               | 24" | 8    | 2                           | 16                         |
| G20-2   | END ROAD WORK          | 48"               | 24" | 8    | 2                           | 16                         |
| W3-4  | BE PREPARED TO STOP    | 48"               | 48" | 16   | 2                           | 32                         |
| W4-2  | LANE ENDS              | 48"               | 48" | 16   | 2                           | 32                         |
| W13-1P  | ADVISORY SPEED         | 30"               | 30" | 6    | 2                           | 13                         |
| W20-1   | ROAD WORK              | 48"               | 48" | 16   | 33                          | 528                        |
| W20-4   | ONE LANE ROAD          | 48"               | 48" | 16   | 2                           | 32                         |
| W20-5   | LANE CLOSED            | 48"               | 48" | 16   | 2                           | 32                         |
| W20-7   | FLAGGER                | 48"               | 48" | 16   | 2                           | 32                         |
| <b>TOTAL</b>                                  |                        |                   |     |      |                             | <b>733</b>                 |

| PROPOSED GUARDRAIL (RESURFACING) |          |  |  |   |          |
|----------------------------------|----------|--|--|---|----------|
| SIDE                             | LOG MILE | TERMINAL ANCHORS   |  |   |          |
|                                  |          | GUARDRAIL<br>TRANSITION<br>27IN TO 31IN<br>705-02.10<br>(EACH) | EARTH PAD<br>FOR END<br>TREATMENT<br>705-04.10<br>(EACH) | TYPE 21<br>MASH TL2<br>(21.875')<br>705-06.30<br>(EACH) |          |
| LT                               | RT       |  |  |   |          |
|                                  | X        | 0.858  | 1  | 1   | 1        |
|                                  | X        | 1.610  | 1  | 1   | 1        |
| <b>TOTALS</b>                    |          |  | <b>2</b>   | <b>2</b>  | <b>2</b> |

| OPEN FRONTAGE |       |            |          |           |       |       |             |                         |  |
|---------------|-------|------------|----------|-----------|-------|-------|-------------|-------------------------|--|
| COUNTY        | ROUTE | BEGIN L.M. | END L.M. | DIRECTION | START | END   | LENGTH (FT) | COMMENTS                |  |
| CLAIBORNE     | 345   | 0          | 8.51     | EB/WB     | 0.466 | 0.496 | 470         | Storage Units/Auto Shop |  |
|               |       |            |          | WB        | 0.573 | 0.615 | 651         | Jack Creech Garage      |  |
|               |       |            |          | EB        | 0.689 | 0.704 | 244         | Residence               |  |
|               |       |            |          | EB        | 6.621 | 6.658 | 575         | Market                  |  |
| <b>TOTAL:</b> |       |            |          |           |       |       | <b>1940</b> |                         |  |

**SEALED BY**



01/08/2024

**STATE OF TENNESSEE  
DEPARTMENT OF TRANSPORTATION**

TABULATED  
QUANTITIES



| TYPE    | YEAR | PROJECT NO.      | SHEET NO. |
|---------|------|------------------|-----------|
| RESURF. | 2024 | STP/HSIP-345(12) | 3         |
|         |      |                  |           |
|         |      |                  |           |

**UTILITY**

- (2) UNLESS OTHERWISE NOTED, ALL UTILITY ADJUSTMENTS WILL BE PERFORMED BY THE UTILITY OR ITS REPRESENTATIVE. THE CONTRACTOR AND UTILITY OWNERS WILL BE REQUIRED TO COOPERATE WITH EACH OTHER IN ORDER TO EXPEDITE THE WORK REQUIRED BY THIS CONTRACT. ON CONTRACTS WHERE CONSTRUCTION STAKES, LINES, AND GRADES ARE CONTRACT ITEMS, THE CONTRACTOR WILL BE REQUIRED TO PROVIDE RIGHT-OF-WAY OR SLOPE STAKES, DITCH OR STREAM BED GRADES, OR OTHER ESSENTIAL SURVEY STAKING TO PREVENT CONFLICTS WITH THE HIGHWAY CONSTRUCTION. FREQUENTLY, THIS WILL BE REQUIRED AS THE FIRST ITEM OF WORK AND AT ANY LOCATION ON THE PROJECT DIRECTED BY THE ENGINEER.
- (3) THE CONTRACTOR WILL PROVIDE ALL NECESSARY PROTECTIVE MEASURES TO SAFEGUARD EXISTING UTILITIES FROM DAMAGE DURING CONSTRUCTION OF THIS PROJECT. IN THE EVENT THAT SPECIAL EQUIPMENT IS REQUIRED TO WORK OVER AND AROUND THE UTILITIES, THE CONTRACTOR WILL BE REQUIRED TO FURNISH SUCH EQUIPMENT. THE COST OF PROTECTING UTILITIES FROM DAMAGE AND FURNISHING SPECIAL EQUIPMENT WILL BE INCLUDED IN THE PRICE BID FOR OTHER ITEMS OF CONSTRUCTION.
- (4) PRIOR TO SUBMITTING HIS BID, THE CONTRACTOR WILL BE SOLELY RESPONSIBLE FOR CONTACTING OWNERS OF ALL AFFECTED UTILITIES IN ORDER TO DETERMINE THE EXTENT TO WHICH UTILITY RELOCATIONS AND/OR ADJUSTMENTS WILL HAVE UPON THE SCHEDULE OF WORK FOR THE PROJECT. WHILE SOME WORK MAY BE REQUIRED 'AROUND' UTILITY FACILITIES THAT WILL REMAIN IN PLACE, OTHER UTILITY FACILITIES MAY NEED TO BE ADJUSTED CONCURRENTLY WITH THE CONTRACTOR'S OPERATIONS. ADVANCE CLEAR CUTTING MAY BE REQUIRED BY THE ENGINEER AT ANY LOCATION WHERE CLEARING IS CALLED FOR IN THE SPECIFICATIONS AND CLEAR CUTTING IS NECESSARY FOR A UTILITY RELOCATION. ANY ADDITIONAL COST WILL BE INCLUDED IN THE UNIT PRICE BID FOR THE CLEARING ITEM SPECIFIED IN THE PLANS.
- (5) THE CONTRACTOR SHALL NOTIFY EACH INDIVIDUAL UTILITY OWNER OF HIS PLAN OF OPERATION IN THE AREA OF THE UTILITIES. PRIOR TO COMMENCING WORK, THE CONTRACTOR SHALL CONTACT THE UTILITY OWNERS AND REQUEST THEM TO PROPERLY LOCATE THEIR RESPECTIVE UTILITY ON THE GROUND. THIS NOTIFICATION SHALL BE GIVEN AT LEAST THREE (3) BUSINESS DAYS PRIOR TO COMMENCEMENT OF OPERATIONS AROUND THE UTILITY IN ACCORDANCE WITH TCA 65-31-106. NOTIFICATION BY CALLING THE TENNESSEE ONE CALL SYSTEM, INC AT 1-800-351-1111 WILL BE REQUIRED.

**UTILITY OWNERS**

**CABLE:**  
**XFINITY**  
 5720 ASHEVILLE HWY.  
 KNOXVILLE, TN 37924  
 CONTACT: DREW MCCAWLEY  
 OFFICE PHONE: (865) 862-5061  
 CELL PHONE: (865) 312-2340  
 Email: james\_mccawley@cable.comcast.com

**ELECTRIC:**  
**LAFOLLETTE UTILITIES BOARD (ELECTRIC DEPT)**  
 P.O. BOX 1411  
 302 NORTH TENNESSEE AVENUE  
 LAFOLLETTE, TN 37766  
 CONTACT: GARY WILLIAMS  
 OFFICE PHONE: (423) 907-1030  
 Email: gary.williams@lubmail.org

**GAS:**  
**CLAIBORNE UTILITIES DISTRICT**  
 P.O. BOX 606 (37825)  
 630 DAVIS DR.  
 NEW TAZEWELL, TN 37824  
 CONTACT: GEORGE COOTS  
 OFFICE PHONE: (423) 626-4282  
 CELL PHONE: (423) 526-7329  
 Email: gcoots@cutdn.com

**SEWER:**  
**CLAIBORNE UTILITIES DISTRICT**  
 P.O. BOX 606 (37825)  
 630 DAVIS DR.  
 NEW TAZEWELL, TN 37824  
 CONTACT: GEORGE COOTS  
 OFFICE PHONE: (423) 626-4282  
 CELL PHONE: (423) 526-7329  
 Email: gcoots@cutdn.com

**TELEPHONE:**  
**AT&T**  
 307 DR. MARTIN LUTHER KING JR PARKWAY  
 MORRISTOWN, TN 37813  
 CONTACT: SAM TRENT  
 OFFICE PHONE: (423) 317-8804  
 CELL PHONE: (865) 789-4715  
 Email: st3528@att.com

**WATER:**  
**CLAIBORNE UTILITIES DISTRICT**  
 P.O. BOX 606 (37825)  
 630 DAVIS DR.  
 NEW TAZEWELL, TN 37824  
 CONTACT: GEORGE COOTS  
 OFFICE PHONE: (423) 626-4282  
 CELL PHONE: (423) 526-7329  
 Email: gcoots@cutdn.com

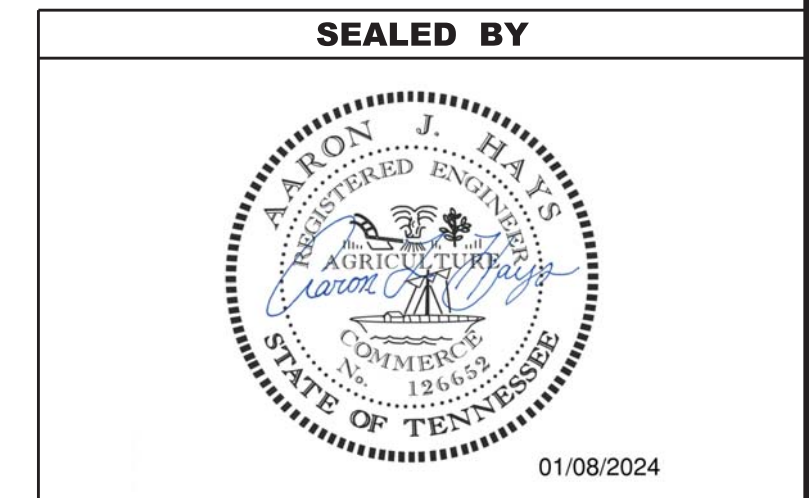

**STATE OF TENNESSEE  
 DEPARTMENT OF TRANSPORTATION**

UTILITY NOTES  
 AND  
 UTILITY OWNERS



# PAVEMENT EDGE DROP-OFF TRAFFIC CONTROL NOTES

| TYPE    | YEAR | PROJECT NO.      | SHEET NO. |
|---------|------|------------------|-----------|
| RESURF. | 2024 | STP/HSIP-345(12) | 4         |
|         |      |                  |           |
|         |      |                  |           |

## A. DIFFERENCES IN ELEVATION BETWEEN ADJACENT TRAFFIC LANES OR TRAFFIC LANE AND SHOULDER WHERE THE TRAFFIC LANE IS BEING USED BY TRAFFIC, CAUSED BY BASE, PAVING OR RESURFACING:

1. DIFFERENCES IN ELEVATION BETWEEN ADJACENT ROADWAY ELEMENTS GREATER THAN 0.75 INCH AND NOT EXCEEDING 1.75 INCHES:
  - a. WARNING SIGNS, UNEVEN LANES (W8-11) AND/OR SHOULDER DROP-OFF WITH PLAQUE (W8-17 AND W8-17P), SHALL BE PLACED IN ADVANCE OF AND THROUGHOUT THE EXPOSED AREA. MAXIMUM SPACING BETWEEN SIGNS SHALL BE 2,000 FEET WITH A MINIMUM OF 2 SIGNS PER EXPOSED AREA. WHERE UNEVEN PAVEMENT IS ENCOUNTERED, SIGNS SHALL BE PLACED ON EACH SIDE OF THE ROADWAY.
  - b. DIFFERENCES IN ELEVATION BETWEEN ADJACENT TRAFFIC LANES BEING UTILIZED BY TRAFFIC CAUSED BY ADDED PAVEMENT SHALL BE ELIMINATED WITHIN THREE WORKDAYS.
  - c. DIFFERENCES IN ELEVATION BETWEEN ADJACENT TRAFFIC LANES BEING UTILIZED BY TRAFFIC CAUSED BY COLD PLANING SHALL BE ELIMINATED WITHIN THREE WORKDAYS.
  - d. WHEN THE DIFFERENCE IN ELEVATION IS BETWEEN THE TRAFFIC LANE BEING UTILIZED BY TRAFFIC AND SHOULDER THE DIFFERENCE IN ELEVATION SHALL BE ELIMINATED WITHIN SEVEN WORKDAYS AFTER THE CONDITION IS CREATED.
2. DIFFERENCES IN ELEVATION BETWEEN ADJACENT ROADWAY ELEMENTS GREATER THAN 1.75 INCHES AND NOT EXCEEDING 6 INCHES, TRAFFIC IS NOT TO BE ALLOWED TO TRAVERSE THIS DIFFERENCE IN ELEVATION.
  - a. SEPARATION SHALL BE ACCOMPLISHED BY DRUMS, BARRICADES OR OTHER APPROVED DEVICES IN ACCORDANCE WITH THE FOLLOWING:
    - (1) WHERE POSTED SPEEDS ARE 50 MPH OR GREATER, SPACING OF THE PROTECTIVE DEVICES SHALL NOT EXCEED 100 FEET.
    - (2) WHERE POSTED SPEEDS ARE LESS THAN 50 MPH, THE MAXIMUM SPACING OF THE PROTECTIVE DEVICES IN FEET SHALL NOT EXCEED TWICE THE POSTED SPEED IN MILES PER HOUR OR 50 FEET, WHICHEVER SPACING IS GREATER.
  - b. IF THE DIFFERENCE IN ELEVATION IS ELIMINATED OR DECREASED TO 2 INCHES OR LESS BY THE END OF EACH WORKDAY, CONES MAY BE USED DURING DAYLIGHT HOURS IN LIEU OF DRUMS, BARRICADES OR OTHER APPROVED PROTECTIVE DEVICES MENTIONED IN PARAGRAPH a, PROVIDED WARNING SIGNS ARE ERECTED. WARNING SIGNS (UNEVEN LANES AND/OR SHOULDER DROP-OFF) SHALL BE PLACED IN ADVANCE OF AND THROUGHOUT THE EXPOSED AREA. MAXIMUM SPACING BETWEEN SIGNS SHALL BE 2,000 FEET WITH A MINIMUM OF 2 SIGNS PER EXPOSED AREA. WHERE UNEVEN PAVEMENT IS ENCOUNTERED, SIGNS SHALL BE PLACED ON EACH SIDE OF THE ROADWAY.
  - c. WHEN THE DIFFERENCE IN ELEVATION IS BETWEEN THE THROUGH TRAFFIC LANE AND THE SHOULDER AND THE ELEVATION DIFFERENCE IS LESS THAN 3 INCHES, THE CONTRACTOR MAY USE WARNING SIGNS AND/OR PROTECTIVE DEVICES AS APPLICABLE AND APPROVED BY THE REGIONAL TRAFFIC ENGINEER. SEE PARAGRAPH a REGARDING USE OF DRUMS, BARRICADES OR OTHER APPROVED PROTECTIVE DEVICES. WARNING SIGNS (UNEVEN LANES AND/OR SHOULDER DROP-OFF) WILL BE PLACED IN ADVANCE OF AND THROUGHOUT THE EXPOSED AREA. MAXIMUM SPACING BETWEEN SIGNS SHALL BE 2,000 FEET WITH A MINIMUM OF 2 SIGNS PER EXPOSED AREA. WHERE UNEVEN PAVEMENT IS ENCOUNTERED, SIGNS SHALL BE PLACED ON EACH SIDE OF THE ROADWAY.

IN THESE SITUATIONS, THE CONTRACTOR SHALL LIMIT HIS OPERATIONS TO ONE WORK ZONE NOT EXCEEDING 2 MILES IN LENGTH UNLESS OTHERWISE NOTED ON THE PLANS OR APPROVED BY THE ENGINEER. ONCE THE CONTRACTOR BEGINS WORK IN A WORK ZONE, A CONTINUOUS OPERATION SHALL BE MAINTAINED UNTIL THE DIFFERENCE IN ELEVATION IS ELIMINATED. SIMULTANEOUS WORK ON SEPARATE ROADWAYS OF DIVIDED HIGHWAYS WILL BE CONSIDERED INDEPENDENTLY IN REGARD TO RESTRICTION OF WORK ZONE ACTIVITY.

## 3. DIFFERENCES IN ELEVATION BETWEEN ADJACENT ROADWAY ELEMENTS GREATER THAN 6 INCHES BUT NOT EXCEEDING 18 INCHES, THE CONTRACTOR, WITH THE ENGINEER'S APPROVAL, MAY UTILIZE ONE OF THE FOLLOWING:

- a. THE CONTRACTOR SHALL ACCOMPLISH SEPARATION BY DRUMS, BARRICADES OR OTHER APPROVED DEVICES IN ACCORDANCE WITH THE FOLLOWING:
  - (1) WHERE POSTED SPEEDS ARE 50 MPH OR GREATER, SPACING OF THE PROTECTIVE DEVICES SHALL NOT EXCEED 100 FEET.
  - (2) WHERE POSTED SPEEDS ARE LESS THAN 50 MPH, THE MAXIMUM SPACING OF THE PROTECTIVE DEVICES IN FEET SHALL NOT EXCEED TWICE THE POSTED SPEED IN MILES PER HOUR OR 50 FEET, WHICHEVER SPACING IS GREATER.

IN ORDER TO USE THIS METHOD, THE CONTRACTOR MUST REDUCE THE DIFFERENCE IN ELEVATION TO 6 INCHES OR LESS BY THE END OF THE WORKDAY THAT THE CONDITION IS CREATED.

- b. THE CONTRACTOR SHALL PROVIDE DRUMS, BARRICADES OR OTHER APPROVED SEPARATION DEVICES AS SPECIFIED IN PARAGRAPH a, AND CONSTRUCT A STONE WEDGE WITH A 4:1 SLOPE, OR FLATTER, TO ELIMINATE THE VERTICAL OFFSET IF THE LOWER ELEVATION IS AT OR BELOW SUBGRADE AT THE END OF EACH DAY.
- c. THE CONTRACTOR SHALL PROVIDE DRUMS, BARRICADES OR OTHER APPROVED SEPARATION DEVICES AS SPECIFIED IN PARAGRAPH a AND IF THE LOWER ELEVATION IS BASE STONE OR ASPHALT PAVEMENT, PLACEMENT OF SUBSEQUENT LAYERS OF PAVEMENT MUST BEGIN THE NEXT WORK DAY AND PROGRESS CONTINUOUSLY UNTIL THE DIFFERENCE IN ELEVATION IS ELIMINATED OR REDUCED TO SIX INCHES OR LESS.
- d. THE CONTRACTOR SHALL PROVIDE SEPARATION BY PORTABLE BARRIER RAIL.

FOR PRECEDING CONDITIONS a, b, AND c, THE CONTRACTOR SHALL USE THE SHOULDER DROP-OFF WARNING SIGN WITH PLAQUE (W8-17 AND W8-17P). IT SHALL BE PLACED IN ADVANCE OF AND THROUGHOUT THE EXPOSED AREA. MAXIMUM SPACING BETWEEN THE SIGNS SHALL BE 2,000 FEET WITH A MINIMUM OF 2 SIGNS PER EXPOSED AREA. IN THESE SITUATIONS, THE CONTRACTOR SHALL LIMIT HIS OPERATIONS TO ONE WORK ZONE NOT EXCEEDING 1 MILE IN LENGTH UNLESS OTHERWISE NOTED ON THE PLANS OR APPROVED BY THE ENGINEER. ONCE THE CONTRACTOR BEGINS WORK IN A WORK ZONE, A CONTINUOUS OPERATION SHALL BE MAINTAINED UNTIL THE DIFFERENCE IS ELIMINATED. SIMULTANEOUS WORK ON SEPARATE ROADWAYS OF DIVIDED HIGHWAYS WILL BE CONSIDERED INDEPENDENTLY IN REGARD TO RESTRICTION OF WORK ZONE ACTIVITY.

## 4. FOR DIFFERENCES IN ELEVATION BETWEEN ADJACENT ROADWAY ELEMENTS GREATER THAN 18 INCHES.

SEPARATION WILL BE PROVIDED BY USE OF PORTABLE BARRIER RAIL.

IN THIS SITUATION THE CONTRACTOR SHALL LIMIT HIS OPERATIONS TO ONE WORK ZONE NOT EXCEEDING 1 MILE IN LENGTH UNLESS OTHERWISE NOTED ON THE PLANS OR APPROVED BY THE ENGINEER. ONCE THE CONTRACTOR BEGINS WORK IN A WORK ZONE, A CONTINUOUS OPERATION SHALL BE MAINTAINED UNTIL THE DIFFERENCE IN ELEVATION IS ELIMINATED. SIMULTANEOUS WORK ON SEPARATE ROADWAYS OF DIVIDED HIGHWAYS WILL BE CONSIDERED INDEPENDENTLY IN REGARD TO RESTRICTION OF WORK ZONE ACTIVITY.

## B. IF THE DIFFERENCE IN ELEVATION IS WITHIN 30 FEET OF THE NEAREST TRAFFIC LANE BEING USED BY TRAFFIC CAUSED BY GRADING, EXCAVATION FOR UTILITIES, DRAINAGE STRUCTURES, UNDERCUTTING, ETC.:

1. IF THE DIFFERENCE IN ELEVATION IS WITHIN 8 FEET OF THE NEAREST TRAFFIC LANE WITH DIFFERENCE IN ELEVATION GREATER THAN 3/4 INCH AND NOT EXCEEDING 2 INCHES.
  - a. WARNING SIGNS (UNEVEN LANES AND/OR SHOULDER DROP-OFF) SHALL BE PLACED IN ADVANCE OF AND THROUGHOUT THE EXPOSED AREA. MAXIMUM SPACING BETWEEN SIGNS SHALL BE 2,000 FEET WITH A MINIMUM OF 2 SIGNS PER EXPOSED AREA. WHERE UNEVEN PAVEMENT IS ENCOUNTERED, SIGNS SHALL BE PLACED ON EACH SIDE OF THE ROADWAY.
2. IF THE DIFFERENCE IN ELEVATION IS WITHIN 8 FEET OF THE NEAREST TRAFFIC LANE WITH DIFFERENCE IN ELEVATION GREATER THAN 2 INCHES AND NOT EXCEEDING 6 INCHES:
  - a. SEPARATION SHALL BE ACCOMPLISHED BY DRUMS, BARRICADES OR OTHER APPROVED DEVICES IN ACCORDANCE WITH THE FOLLOWING:
    - (1) WHERE POSTED SPEEDS ARE 50 MPH OR GREATER, SPACING OF THE PROTECTIVE DEVICES SHALL NOT EXCEED 100 FEET.
    - (2) WHERE POSTED SPEEDS ARE LESS THAN 50 MPH THE MAXIMUM SPACING OF THE PROTECTIVE DEVICES IN FEET SHALL NOT EXCEED TWICE THE POSTED SPEED IN MILES PER HOUR OR 50 FEET, WHICHEVER SPACING IS GREATER.
3. IF THE DIFFERENCE IN ELEVATION IS WITHIN 8 FEET OF THE NEAREST TRAFFIC LANE WITH DIFFERENCE IN ELEVATION GREATER THAN 6 INCHES:
  - a. SEPARATION SHALL BE ACCOMPLISHED BY DRUMS, BARRICADES OR OTHER APPROVED DEVICES IN ACCORDANCE WITH THE FOLLOWING:
    - (1) WHERE POSTED SPEEDS ARE 50 MPH OR GREATER, SPACING OF THE PROTECTIVE DEVICES SHALL NOT EXCEED 100 FEET.
    - (2) WHERE POSTED SPEEDS ARE LESS THAN 50 MPH THE MAXIMUM SPACING OF THE PROTECTIVE DEVICES IN FEET SHALL NOT EXCEED TWICE THE POSTED SPEED IN MILES PER HOUR OR 50 FEET, WHICHEVER SPACING IS GREATER.
  - b. ELIMINATE VERTICAL OFFSET BY CONSTRUCTING A STONE WEDGE OR GRADING TO A 4:1 SLOPE, OR FLATTER, OR USE PORTABLE BARRIER RAIL.

THE CONTRACTOR SHALL SCHEDULE THE WORK SO AS TO MINIMIZE THE TIME TRAFFIC IS EXPOSED TO AN ELEVATION DIFFERENCE. ONCE THE CONTRACTOR BEGINS AN ACTIVITY THAT CREATES AN ELEVATION DIFFERENCE WITHIN 8 FEET OF A TRAFFIC LANE, THE ACTIVITY SHALL BE PURSUED AS A CONTINUOUS OPERATION UNTIL THE ELEVATION DIFFERENCE IS ELIMINATED.

## C. IF THE DIFFERENCE IN ELEVATION IS FARTHER THAN 8 FEET FROM THE NEAREST TRAFFIC LANE BUT NOT MORE THAN 30 FEET FROM THE NEAREST TRAFFIC LANE:

SEPARATION SHALL BE ACCOMPLISHED BY DRUMS, BARRICADES OR OTHER APPROVED DEVICES IN ACCORDANCE WITH THE FOLLOWING:

1. WHERE POSTED SPEEDS ARE 50 MPH OR GREATER, SPACING OF THE PROTECTIVE DEVICES SHALL NOT EXCEED 100 FEET.
2. WHERE POSTED SPEEDS ARE LESS THAN 50 MPH, THE MAXIMUM SPACING OF THE PROTECTIVE DEVICES IN FEET SHALL NOT EXCEED TWICE THE POSTED SPEED IN MILES PER HOUR OR 50 FEET, WHICHEVER SPACING IS GREATER.

THE CONTRACTOR SHALL SCHEDULE THE WORK SO AS TO MINIMIZE THE TIME TRAFFIC IS EXPOSED TO AN ELEVATION DIFFERENCE. ONCE THE CONTRACTOR BEGINS AN ACTIVITY THAT CREATES AN ELEVATION DIFFERENCE, THE ACTIVITY SHALL BE PURSUED AS A CONTINUOUS OPERATION UNTIL THE ELEVATION DIFFERENCE IS ELIMINATED.

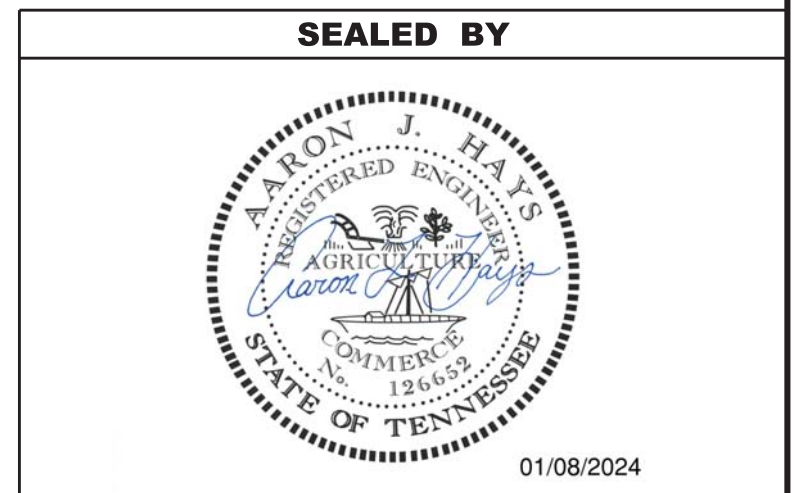

**STATE OF TENNESSEE  
DEPARTMENT OF TRANSPORTATION**

**PAVEMENT EDGE  
DROP-OFF NOTES  
FOR  
TRAFFIC CONTROL**



| TYPE   | YEAR | PROJECT NO.      | SHEET NO. |
|--------|------|------------------|-----------|
| RESURF | 2024 | STP/HSIP-345(12) | R1        |
|        |      |                  |           |
|        |      |                  |           |
|        |      |                  |           |

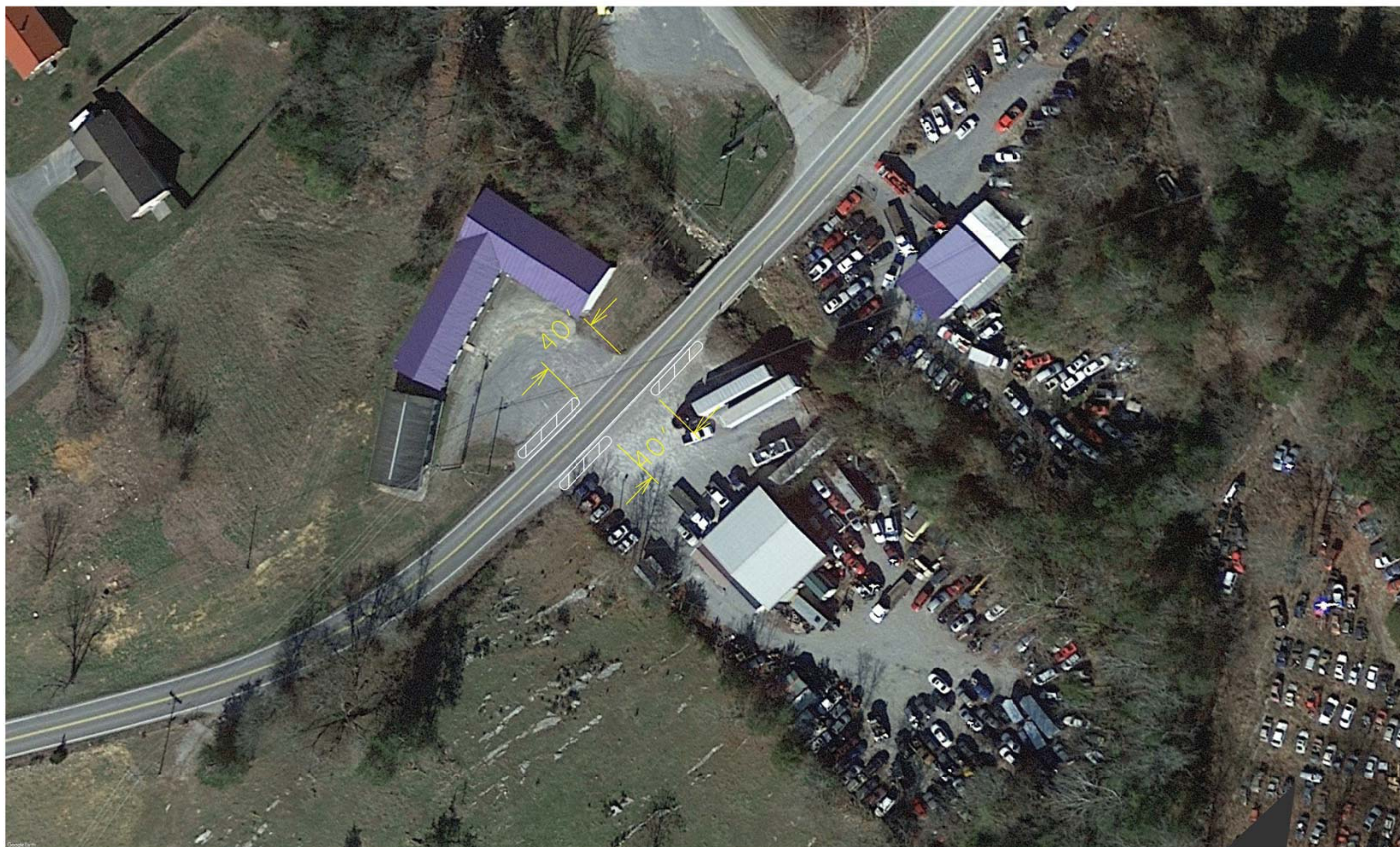

FOR REFERENCE ONLY.  
PROVIDED BY REGION 1 TRAFFIC.

SEALED BY

STATE OF TENNESSEE  
DEPARTMENT OF TRANSPORTATION

CHANNELIZED SHOULDER  
FOR ACCESS MANAGEMENT  
LM 0.466 TO 0.496  
STATE ROUTE 345  
CLAIBORNE COUNTY

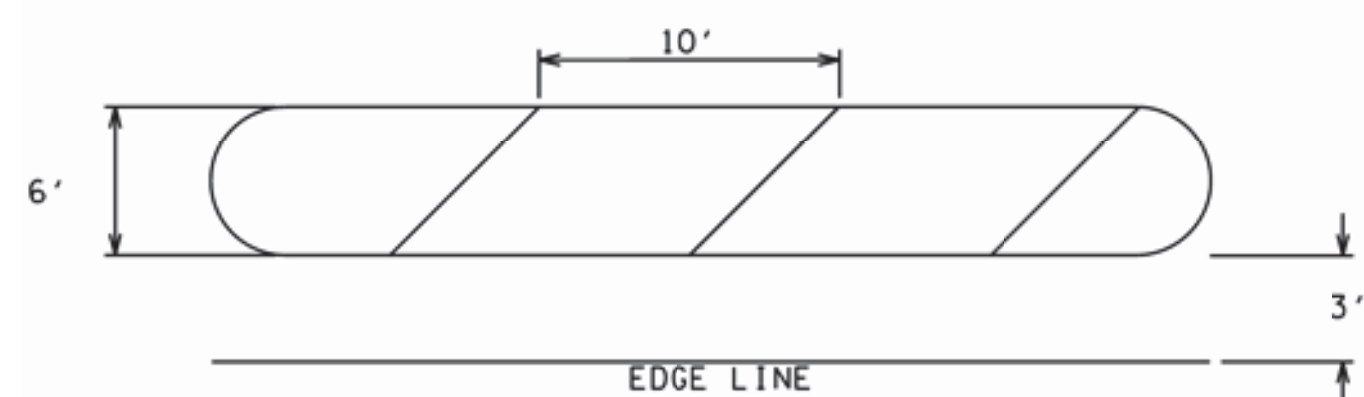

TYPICAL SECTION



| TYPE   | YEAR | PROJECT NO.      | SHEET NO. |
|--------|------|------------------|-----------|
| RESURF | 2024 | STP/HSIP-345(12) | R2        |
|        |      |                  |           |
|        |      |                  |           |
|        |      |                  |           |



FOR REFERENCE ONLY.  
PROVIDED BY REGION 1 TRAFFIC.

SEALED BY

STATE OF TENNESSEE  
DEPARTMENT OF TRANSPORTATION

CHANNELIZED SHOULDER  
FOR ACCESS MANAGEMENT  
LM 0.573 TO 0.615  
STATE ROUTE 345  
CLAIBORNE COUNTY

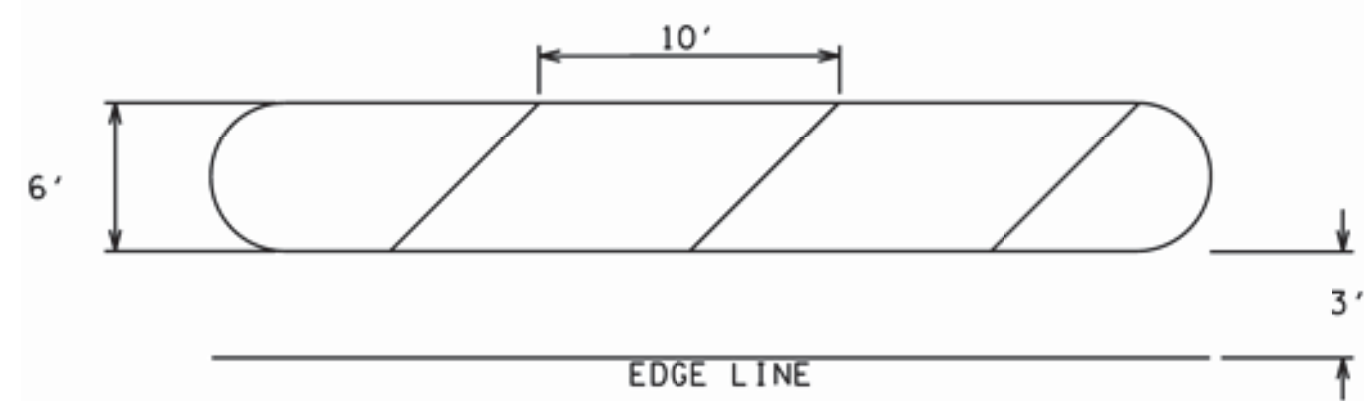

TYPICAL SECTION



| TYPE   | YEAR | PROJECT NO.      | SHEET NO. |
|--------|------|------------------|-----------|
| RESURF | 2024 | STP/HSIP-345(12) | R3        |
|        |      |                  |           |
|        |      |                  |           |
|        |      |                  |           |



FOR REFERENCE ONLY.  
PROVIDED BY REGION 1 TRAFFIC.

SEALED BY

STATE OF TENNESSEE  
DEPARTMENT OF TRANSPORTATION

CHANNELIZED SHOULDER  
FOR ACCESS MANAGEMENT  
LM 0.689 TO 0.704  
STATE ROUTE 345  
CLAIBORNE COUNTY

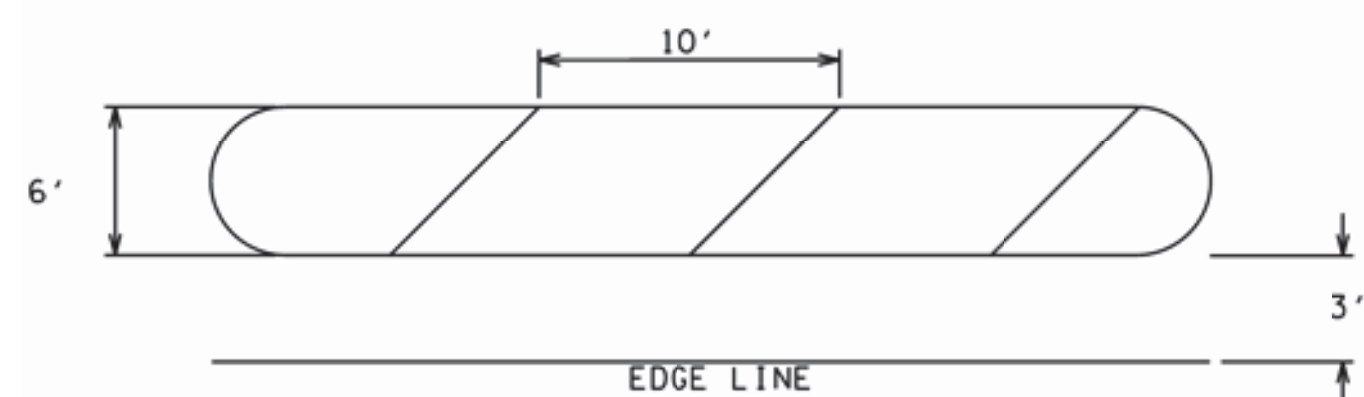

TYPICAL SECTION



| TYPE   | YEAR | PROJECT NO.      | SHEET NO. |
|--------|------|------------------|-----------|
| RESURF | 2024 | STP/HSIP-345(12) | R4        |
|        |      |                  |           |
|        |      |                  |           |
|        |      |                  |           |



FOR REFERENCE ONLY.  
PROVIDED BY REGION 1 TRAFFIC.

SEALED BY

STATE OF TENNESSEE  
DEPARTMENT OF TRANSPORTATION

CHANNELIZED SHOULDER  
FOR ACCESS MANAGEMENT  
LM 6.621 TO 6.658  
STATE ROUTE 345  
CLAIBORNE COUNTY

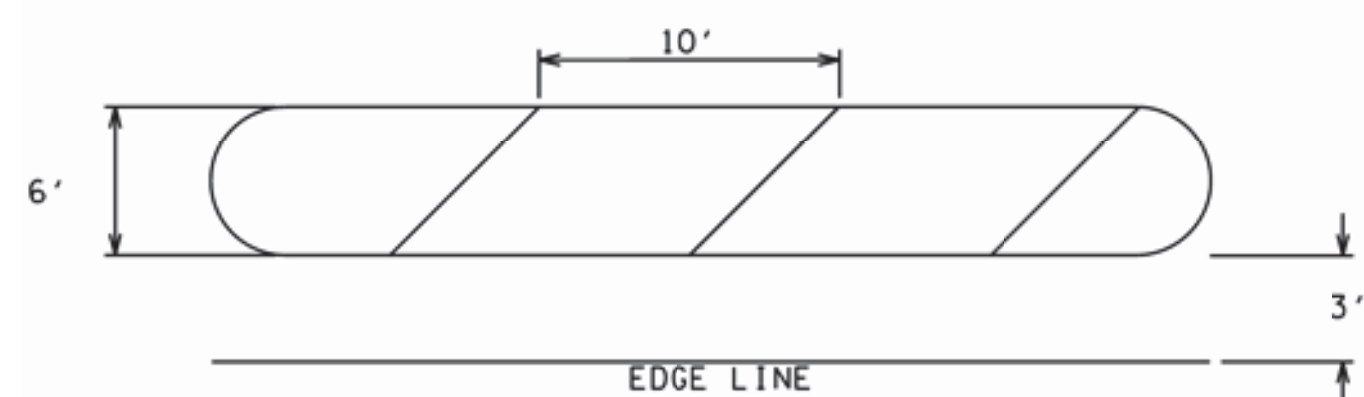

TYPICAL SECTION